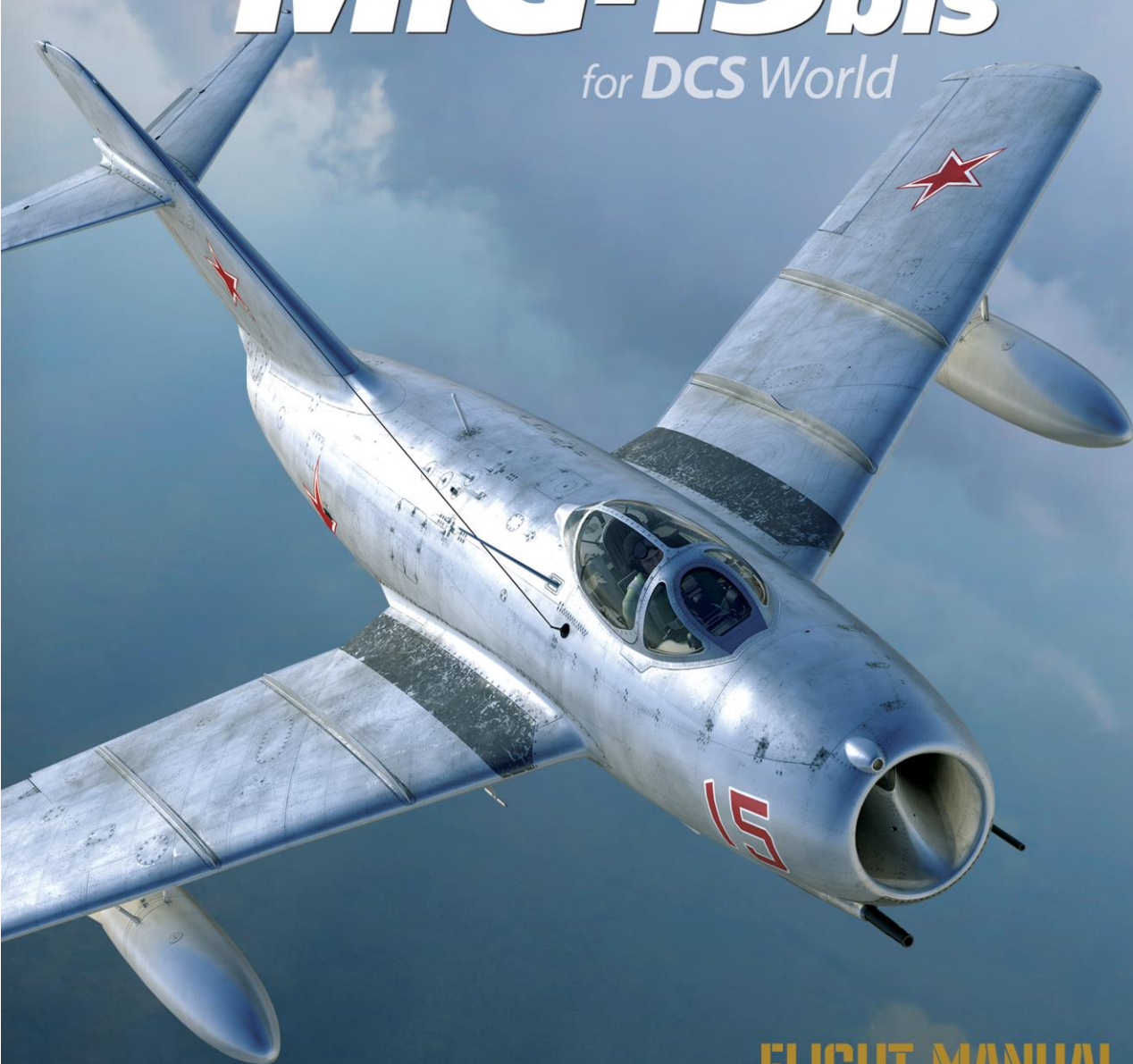


D I G I T A L   C O M B A T   S I M U L A T O R

# MiG-15bis

for DCS World



FLIGHT MANUAL



THE FIGHTER COLLECTION



Eagle Dynamics





# TABLE OF CONTENTS

TABLE OF CONTENTS.....	1
Important notice! .....	9
<b>1. AIRCRAFT HISTORY.....</b>	<b>11</b>
<b>2. MISSION OVERVIEW AND MAIN SPECIFICATIONS .....</b>	<b>13</b>
2.1. MISSION OVERVIEW.....	13
2.2. MAIN SPECIFICATIONS.....	13
2.2.1. Specifications table.....	13
2.2.2. Aircraft dimensions.....	14
<b>3. AIRCRAFT AND ENGINE DESIGN .....</b>	<b>17</b>
3.1. AIRCRAFT DESIGN.....	17
3.1.1. Fuselage.....	17
3.1.2. Canopy.....	20
3.1.3. Wing .....	22
Ailerons .....	22
Flaps .....	23
3.1.4. Air brakes .....	25
3.1.5. Empennage.....	26
3.1.6. Landing gear.....	27
Landing gear emergency release.....	32
3.2. ENGINE AND RELATED SYSTEMS.....	34
3.2.1. General design and layout .....	34
3.2.2. Engine oil system .....	34
3.2.3. Engine operation.....	35
3.2.4. Engine controls .....	37
VK-1 engine fuel automatics.....	38
<b>4. COCKPIT .....</b>	<b>43</b>
4.1. AIRCRAFT AND ENGINE CONTROLS .....	44
4.1.1. Flight control stick.....	45
4.1.2. Pedals .....	47
4.1.3. Engine throttle handle .....	48
4.1.4. Flaps control .....	48
4.1.5. Speedbrake control .....	48

4.2.	INSTRUMENT PANEL .....	48
4.2.1.	<i>55° flaps extension angle signal lamp</i> .....	49
4.2.2.	<i>VD-17 altimeter</i> .....	50
4.2.3.	<i>KUS-1200 airspeed indicator</i> .....	51
4.2.4.	<i>Radio marker beacon fly-over lamp</i> .....	52
4.2.5.	<i>Extend landing gear warning lamp</i> .....	52
4.2.6.	<i>AChS-1 cockpit chronograph (clock)</i> .....	53
4.2.7.	<i>AGK-47B attitude indicator</i> .....	55
4.2.8.	<i>Generator off warning lamp</i> .....	58
4.2.9.	<i>VAR-75 vertical velocity indicator</i> .....	59
4.2.10.	<i>Gun camera status lamp</i> .....	60
4.2.11.	<i>300 liters warning lamp</i> .....	61
4.2.12.	<i>Air restart ignition off memo light</i> .....	61
4.2.13.	<i>ARK-5 SUP-7 automatic direction finder</i> .....	62
4.2.14.	<i>DGMK-3 gyromagnetic compass indicator</i> .....	62
4.2.15.	<i>TE-15 electrical tachometer</i> .....	66
4.2.16.	<i>TGZ-47 exhaust gas temperature gauge</i> .....	67
4.2.17.	<i>VA-340 volt-/ammeter</i> .....	68
4.2.18.	<i>UVPD-3 cockpit altitude and pressure indicator</i> .....	69
4.2.19.	<i>EM-10 electrical remote-reading fuel pressure gauge</i> .....	70
4.2.20.	<i>Fast compass slave button</i> .....	71
4.2.21.	<i>EMI-3R three-pointer indicator</i> .....	72
4.2.22.	<i>Second fuel tank empty warning lamp</i> .....	73
4.2.23.	<i>Engine start prohibited lamp</i> .....	73
4.2.24.	<i>KES-857 fuel meter</i> .....	74
4.2.25.	<i>M-0,95 Mach number indicator</i> .....	75
4.2.26.	<i>PRV-46 radar altimeter</i> .....	76
4.2.27.	<i>Landing gear hydraulic lever</i> .....	77
4.2.28.	<i>Landing gear position indication panel</i> .....	77
4.2.29.	<i>MK-12 oxygen pressure gauge</i> .....	78
4.2.30.	<i>V-45 landing light switch</i> .....	78
4.2.31.	<i>IK-14 oxygen indicator</i> .....	79
4.3.	LEFT SIDE .....	80
	<i>Throttle console</i> .....	84
4.4.	ARMAMENT CONTROL PANEL .....	87
4.5.	ASP-3N GUNSIGHT .....	90
4.6.	RIGHT SIDE .....	90
	<i>Right side horizontal panel</i> .....	93
4.7.	BACK SIDE OF THE COCKPIT .....	95

<b>5.</b>	<b>SYSTEMS .....</b>	<b>98</b>
5.1.	FLIGHT CONTROL SYSTEM.....	98
5.1.1.	<i>Elevator in the flight control system (pitch control).....</i>	<i>99</i>
5.1.2.	<i>Ailerons in the flight control system (roll control).....</i>	<i>100</i>
5.1.3.	<i>Rudder in the control system (directional or yaw control)..</i>	<i>101</i>
5.1.4.	<i>Flaps control .....</i>	<i>102</i>
	<i>Specific features of flap extension process .....</i>	<i>103</i>
5.1.5.	<i>Speedbrake control .....</i>	<i>104</i>
5.2.	POWER SUPPLY SYSTEM .....	105
5.3.	FUEL SYSTEM .....	107
	<i>Operation .....</i>	<i>108</i>
	<i>Fuel tank sequencing.....</i>	<i>108</i>
	<i>System of external tanks .....</i>	<i>109</i>
5.4.	UTILITY HYDRAULIC SYSTEM .....	110
5.4.1.	<i>Description of hydraulic system elements.....</i>	<i>111</i>
	<i>Landing gear control system .....</i>	<i>111</i>
	<i>Flaps control system.....</i>	<i>112</i>
	<i>Speedbrake control system .....</i>	<i>112</i>
	<i>Hydraulic system valves.....</i>	<i>112</i>
	<i>Relief valve .....</i>	<i>112</i>
	<i>Hydraulic accumulator .....</i>	<i>112</i>
5.4.2.	<i>Hydraulic system operation .....</i>	<i>112</i>
5.5.	LATERAL CONTROL HYDRAULIC SYSTEM .....	113
	<i>Booster hydraulic system operation .....</i>	<i>114</i>
5.6.	ENVIRONMENTAL CONTROL SYSTEM.....	116
	<i>Cockpit objects connected to the ECS.....</i>	<i>117</i>
	<i>Cockpit pressurization supply system operation .....</i>	<i>117</i>
	<i>RD-2I-220 pressure regulator operation.....</i>	<i>118</i>
	<i>Cockpit air supply valve .....</i>	<i>118</i>
	<i>Cockpit auxiliary ventilation system .....</i>	<i>120</i>
5.7.	PNEUMATIC SYSTEM.....	121
5.7.1.	<i>Pneumatic system purpose, structure and operation.....</i>	<i>122</i>
	<i>Cockpit objects related to the pneumatic system .....</i>	<i>123</i>
	<i>Pneumatic system operation .....</i>	<i>124</i>
	<i>Braking system .....</i>	<i>125</i>
	<i>Brake control .....</i>	<i>125</i>
5.7.2.	<i>Emergency pneumatic system purpose, structure and operation</i>	<i>126</i>
	<i>Cockpit objects related to emergency pneumatic system.....</i>	<i>126</i>

	<i>Emergency landing gear extension (with explanations)</i> .....	127
	<i>Emergency flaps extension</i> .....	127
5.8.	<b>MiG-15BIS ARMAMENT</b> .....	128
	<i>Cockpit objects connected to the weapon system</i> .....	130
5.8.1.	<i>Gun armament</i> .....	131
	<i>Purpose and structure of gun armament</i> .....	131
	<i>Main characteristics of 23 mm NR-23 automatic cannons</i> .....	132
	<i>Main characteristics of 37 mm N-37D automatic cannon</i> .....	133
	<i>Guns undercarriage</i> .....	134
	<i>Fire and reloading electrical circuits</i> .....	134
	<i>Guns reloading system</i> .....	135
5.8.2.	<i>Bombs and related equipment</i> .....	136
5.8.3.	<i>ASP-3N gunsight</i> .....	139
	<i>General description of ASP-3N</i> .....	141
	<i>ASP-3N gunsight "computer" operation principle</i> .....	142
	<i>General description of the pilot operation during aiming</i> .....	143
	<i>Preparing gunsight for aerial target engagement</i> .....	146
5.8.4.	<i>S-13 gun camera</i> .....	148
5.8.5.	<i>Armor</i> .....	150
5.8.6.	<i>Flare launcher (signal flare cartridge)</i> .....	150
5.9.	<b>FIRE EXTINGUISHING SYSTEM</b> .....	151
	<i>Pilot actions in case of fire</i> .....	152
5.10.	<b>OXYGEN SUPPLY SYSTEM</b> .....	153
	<i>Items in the cockpit related to the oxygen supply system</i> .....	154
	<i>Oxygen supply system operation</i> .....	155
5.11.	<b>LIGHTING EQUIPMENT</b> .....	156
5.11.1.	<i>Cockpit lighting equipment</i> .....	156
	<i>Description of cockpit objects related to interior cockpit lighting</i> .....	158
	<i>Operation peculiarity of ARUFOSh lamps</i> .....	160
5.11.2.	<i>Exterior lighting equipment</i> .....	160
	<i>Description of cockpit objects, related to exterior lighting equipment</i> .....	162
<b>6.</b>	<b>RADIO COMMUNICATION AND RADIO ELECTRONIC EQUIPMENT</b> .....	<b>164</b>
6.1.	<b>RADIO COMMUNICATION EQUIPMENT</b> .....	165
6.1.1.	<i>RSI-6K transmitter</i> .....	165
6.1.2.	<i>RSI-6M1 receiver</i> .....	168
6.1.3.	<i>RSI-6 in game</i> .....	171
	<i>RSI-6 transceiver tuning</i> .....	171

6.2.	RADIO COMMUNICATION .....	174
6.3.	RADIO ELECTRONIC EQUIPMENT .....	174
6.3.1.	<i>ARK-5 automatic direction finder .....</i>	<i>174</i>
	<i>Cockpit objects connected to ARK-5 .....</i>	<i>175</i>
	<i>Direction finder control panel .....</i>	<i>176</i>
	<i>ARK-5 direction finder turning on and tuning procedure.....</i>	<i>180</i>
	<i>Power supply and ARK-5 operation.....</i>	<i>183</i>
6.3.2.	<i>MRP-48P marker beacon receiver .....</i>	<i>183</i>
	<i>MRP-48P enabling .....</i>	<i>184</i>
6.3.3.	<i>RV-2 radar altimeter .....</i>	<i>185</i>
	<i>Enabling and setting up radar altimeter .....</i>	<i>186</i>
<b>7.</b>	<b>FLIGHT AND RELATED PROCEDURES .....</b>	<b>188</b>
7.1.	START, ENGINE TESTING, AIRCRAFT SYSTEMS CONTROL, TAXIING TO RUNWAY 188	
7.1.1.	<i>Cockpit equipment check .....</i>	<i>188</i>
7.1.2.	<i>* Oxygen supply system check.....</i>	<i>189</i>
7.1.3.	<i>Preparing equipment for startup.....</i>	<i>190</i>
7.1.4.	<i>Engine startup.....</i>	<i>192</i>
7.1.5.	<i>Pilot actions in case of unsuccessful engine start.....</i>	<i>195</i>
7.1.6.	<i>* Engine operation check.....</i>	<i>196</i>
7.1.7.	<i>* Hydraulic system check.....</i>	<i>197</i>
7.1.8.	<i>Pilot actions before taxiing .....</i>	<i>199</i>
7.2.	TAKEOFF AND CLIMB .....	201
7.2.1.	<i>Forces and moments affecting airplane during takeoff and climb 204</i>	
	<i>Takeoff roll .....</i>	<i>204</i>
	<i>Lift-off and acceleration .....</i>	<i>204</i>
	<i>Climb.....</i>	<i>205</i>
7.2.2.	<i>Correction of deviations during takeoff .....</i>	<i>205</i>
	<i>1. Difficulties with maintaining direction during beginning of takeoff roll .....</i>	<i>205</i>
	<i>2. Nose gear lifts off at less than required speed .....</i>	<i>206</i>
7.3.	APPROACH AND LANDING .....	206
7.3.1.	<i>Approach .....</i>	<i>206</i>
7.3.2.	<i>Correction of wrong landing approach and missed approach procedure 208</i>	
	<i>Correction of wrong approach .....</i>	<i>208</i>
	<i>Missed approach procedure .....</i>	<i>208</i>

7.3.3.	<i>Forces and moments affecting airplane during landing.....</i>	209
1.	<i>Landing flare.....</i>	209
2.	<i>Touchdown and first part of landing run .....</i>	209
3.	<i>Second part of landing run.....</i>	210
7.4.	PILOT ACTIONS WHEN FLYING WITH DROP TANKS.....	210
7.4.1.	<i>Before takeoff.....</i>	210
7.4.2.	<i>While flying.....</i>	212
7.4.3.	<i>Drop tanks release .....</i>	212
7.5.	ENGINE SHUTDOWN.....	213
<b>8.</b>	<b>OPERATING LIMITATIONS .....</b>	<b>215</b>
8.1.1.	<i>Primary limitations.....</i>	215
8.1.2.	<i>Maximum airspeed and Mach number (M) limitations .....</i>	215
8.1.3.	<i>Minimum airspeed limitations.....</i>	216
<b>9.</b>	<b>AIRCRAFT AERODYNAMIC PARTICULARS.....</b>	<b>219</b>
9.1.1.	<i>Climb rate.....</i>	219
9.1.2.	<i>Takeoff and landing characteristics.....</i>	219
	<i>Primary airspeed references for takeoff and landing .....</i>	219
	<i>Other takeoff particulars.....</i>	219
	<i>Other landing particulars.....</i>	220
9.1.3.	<i>Controllability.....</i>	220
	<i>Pitch trim particulars.....</i>	220
9.1.4.	<i>Response to rudder deflection.....</i>	221
9.1.5.	<i>Uncommanded roll .....</i>	221
9.1.6.	<i>Stall and spin .....</i>	222
	<i>Stall recovery.....</i>	223
	<i>Spin recovery.....</i>	223
9.1.7.	<i>Other aerodynamic particulars.....</i>	224
<b>10.</b>	<b>COMBAT EMPLOYMENT .....</b>	<b>226</b>
10.1.	ASP-3N GUNSIGHT DISTANCE MEASURING DEVICE USAGE.....	226
	<i>Procedure for finding operating ranges for accurate distance</i>	
	<i>measurement.....</i>	227
10.1.1.	<i>Shooting at aerial targets.....</i>	228
10.1.2.	<i>Shooting at ground targets .....</i>	228
10.2.	BOMBING AIMING.....	229
	<i>Procedure for bombing aiming and release .....</i>	229
<b>11.</b>	<b>FEATURES OF DCS: MIG-15BIS.....</b>	<b>233</b>



<b>12.</b>	<b>EMERGENCY PROCEDURES .....</b>	<b>243</b>
12.1.	EMERGENCY PROCEDURES .....	243
12.1.1.	<i>Engine failure in flight.....</i>	243
12.1.2.	<i>Engine air restart.....</i>	244
12.1.3.	<i>Fuel pressure drop .....</i>	245
12.1.4.	<i>Engine RPM drop.....</i>	245
12.1.5.	<i>Engine stall .....</i>	246
12.1.6.	<i>Engine fire .....</i>	246
12.1.7.	<i>Cockpit fogging (WIP) .....</i>	247
12.1.8.	<i>Aircraft oxygen supply system failure.....</i>	247
12.1.9.	<i>Cockpit decompression in stratosphere .....</i>	247
12.1.10.	<i>Failure of aileron power unit (lateral control hydraulic system) 247</i>	
12.1.11.	<i>Generator failure .....</i>	248
12.1.12.	<i>Radio communication failure .....</i>	248
12.1.13.	<i>Aircraft lighting facilities failure at night .....</i>	249
	<i>Flight navigation instrument failure in bad weather .....</i>	249
12.1.14.	<i>Attitude indicator failure .....</i>	249
12.1.15.	<i>Speed indicator, altimeter and climb indicator failure .....</i>	249
12.1.16.	<i>Automatic direction finder (ADF) failure .....</i>	250
12.1.17.	<i>Gyromagnetic compass failure.....</i>	250
12.1.18.	<i>Emergency landing gear and flaps extension.....</i>	250
12.1.19.	<i>Landing when the nose gear leg is not extended.....</i>	251
12.1.20.	<i>Forced landing .....</i>	251
<b>13.</b>	<b>HOW TO PLAY .....</b>	<b>253</b>
13.1.	GENERAL INFORMATION .....	253
	<i>Interaction between player and virtual cockpit .....</i>	254
13.2.	BUILT-IN MISSIONS .....	254
	<i>Procedure for built-in mission start: .....</i>	254
13.3.	CONTROLLING AIRPLANE AND VARIOUS COCKPIT OBJECTS .....	256
13.3.1.	<i>Controlling airplane with joystick .....</i>	257
13.3.2.	<i>Controlling airplane with keyboard.....</i>	257
13.3.3.	<i>Interacting with cabin objects with the mouse .....</i>	258
13.4.	CONTROLLING VIRTUAL PILOT HEAD POSITION AND VIEWS IN THE 6DOF COCKPIT 259	
13.4.1.	<i>Controlling virtual pilot head position in the 6DOF cockpit. 259 Head movement, rotation and image zooming with keyboard and mouse .....</i>	260

13.4.2.	<i>Controlling views in the 6DOF cockpit</i> .....	263
13.5.	SPECIAL GAME SETTINGS .....	264
13.6.	INFORMATIONAL HELP TO THE PLAYER .....	265
13.6.1.	<i>AI helper</i> .....	265
13.6.2.	<i>Kneeboard</i> .....	266
	<i>ABBREVIATIONS AND TERMS</i> .....	268
<b>14.</b>	<b>ABBREVIATIONS AND TERMS</b> .....	<b>269</b>
	<i>THE METRIC SYSTEM AND EQUIVALENTS, CONVERSION FACTORS.</i>	272
<b>15.</b>	<b>THE METRIC SYSTEM AND EQUIVALENTS, CONVERSION FACTORS</b> .....	<b>273</b>
15.1.1.	<i>The Metric System and Equivalents</i> .....	273
15.1.2.	<i>Approximate Conversion Factors</i> .....	274
	<i>DEVELOPERS</i> .....	276
<b>16.</b>	<b>DEVELOPERS</b> .....	<b>277</b>
	<i>BELSIMTEK</i> .....	277
	<i>MANAGEMENT</i> .....	277
	<i>PROGRAMMERS</i> .....	277
	<i>DESIGNERS</i> .....	277
	<i>SCIENCE SUPPORT</i> .....	278
	<i>TESTER STAFF</i> .....	278
	<i>IT AND CUSTOMER SUPPORT MISSION AND CAMPAIGNS</i> .....	278
	<i>ARTISTS AND SOUND</i> .....	278
	<i>TRAINING</i> .....	279
	<i>SPECIAL THANKS</i> .....	279
	<i>BIBLIOGRAPHY AND SOURCES</i> .....	280
<b>17.</b>	<b>BIBLIOGRAPHY AND SOURCES</b> .....	<b>281</b>

***Important notice!***

This document includes the history of the airplane and provides brief descriptions of the aircraft's structural elements, systems, equipment and their corresponding cockpit controls.

Note that the information about individual systems is not concentrated in a single section, but scattered all over the document, i.e. elements of the aircraft are described in one section of this manual while the controls and features of operation are described in another section. This approach is used due to multiple interconnections between the elements of the aircraft. For this reason, a system is first described as an element of aircraft design and then as an object of cockpit control. If you are willing to get a deeper understanding of the design and features of the MiG-15bis, we recommend that you carefully study all the available references.

Notes in small print are more detailed explanations for users who want to gain a deeper understanding of a mechanism, system or equipment.

For convenience, this manual contains [cross-references](#) and [hyperlinks](#) that connect all references to the same object throughout the text, or when it is necessary to describe the operation of an object in conjunction with another one. To follow a hyperlink in this PDF document, click it with the left mouse button. Use the keys |[Alt + <](#)| (arrow left) or |[Alt + >](#)| (arrow right) to return.

If you are a new player just getting acquainted with DCS World, it is recommended to visit the [HOW TO PLAY](#) section first.



**1**

# AIRCRAFT HISTORY

## 1. AIRCRAFT HISTORY

DCS: MiG-15bis is a simulation of the Soviet Union's vanguard jet fighter and one of the most mass-produced jets in history – the Mikoyan-Gurevich MiG-15. The MiG-15 gained fame in the skies over Korea where it battled the American F-86 Sabre and other allied aircraft during the Korean War (1950-1953). The MiG-15's appearance in Korea became known as the "Korean surprise" due to its unexpected combat effectiveness. From late December 1950 up to the end of war in July 1953, the MiG-15 proved to be the primary aerial opponent of the equally distinguished F-86 Sabre.

The MiG-15 is a swept-wing jet fighter developed by the Mikoyan-Gurevich experimental design bureau (OKB) in the late 1940s, entering service with the Soviet Air and Air Defense Forces in 1949. The aircraft has an extensive combat history that includes several conflicts apart from the Korean War, such as the Arab-Israeli wars. Thanks to its high reliability, remarkable performance and ease of use – both in flight training and operation –, the MiG-15 remained in service with the USSR for nearly 20 years and in foreign service until 2006 (Albanian Air Force)! There were numerous modifications: Apart from its main purpose as a fighter, it was used as a reconnaissance aircraft, target aircraft and prototype for a variety of weapons and systems tests.

Modifications of the MiG-15 include the MiG-15S, MiG-15PB, MiG-15bis, MiG-15Rbis(SR) tactical reconnaissance version, MiG-15Sbis(SD-UPB) escort fighter, MiG-15UTM, MiG-15P UTI two-seat trainer and the MiG-15M radio-controlled target drone. In total, over 15,000 of these aircraft were manufactured (almost twice as many as its American counterpart, the F-86 Sabre).

The MiG-15bis featured in this simulation is an upgraded model of the original MiG-15, powered by the more powerful Soviet-produced Klimov VK-1 engine in place of the original British Rolls-Royce Nene-I (II). The aircraft is equipped with three cannons (two 23 mm and one 37 mm) and can be further armed with two 100 kg bombs.



# 2

## MISSION OVERVIEW AND MAIN SPECIFICATIONS

## 2. MISSION OVERVIEW AND MAIN SPECIFICATIONS

### 2.1. Mission overview

The aircraft's main purpose is to gain air superiority (during the daytime). It also has (limited) capability of being a strike plane.

It is a swept-wing single-engine aircraft with a tricycle landing gear: two main gears and a nose gear ([Figure 2.1](#)).

Unlike the F-86F, the MiG-15bis uses a hydraulic actuator only for the roll channel. The aircraft has three powerful cannons: 2x 23 mm and 1x 37 mm.

### 2.2. Main specifications

#### 2.2.1. Specifications table

Table 2.1

Specifications	UNIT	Value
<b>NORMAL CREW</b>	per aircraft	1
<b>OPERATIONAL CHARACTERISTICS</b>		
Max allowed takeoff weight	lbs / kg	13459 / 6105
Empty weight	lbs / kg	7892 / 3580
Useful load (with 100 kg pilot)	lbs / kg	2983 / 1353
Normal takeoff weight	lbs / kg	11120 / 5044
Internal fuel capacity (fuel density 0.83 kg/l)	lbs/gal // kg/l	2584/373 // 1172/1412
Cruise speed (at 10.000 m, weight within 4.600-4.900 kg)	indicated airspeed (IAS) kts / km/h	243-254 / 450-470
Fuel consumption rate (air patrol at 10.000 m, 350 km/h IAS, weight within 4.600-4.900 kg, fuel density 0.83 kg/l)	lbs/h // kg/h	1464 // 664
Maximum speed at sea level, true airspeed (TAS)	kts / km/h	581 / 1076
Maximum speed at 10.000 m (33.000 feet), true airspeed (TAS)	kts / km/h	535 / 990
Service ceiling (for 5044 kg take-off weight)	ft / m	51016 / 15500
Time of climb altitude up to 5000 m (at 11.560 rpm and 680-560 km/h TAS)	min	around 2
Maximum rate-of-climb (at 11.560 rpm): at 1000 m altitude	m/min // km/h true airspeed	2790 // 710 2100 // 710

Specifications	UNIT	Value
at 5000 m altitude	(TAS) optimal for climb	
Maximum range (w/o drop tank): altitude 10.000 m, 450-470 km/h IAS	nm / km	648 / 1200
Maximum range (with 2x300 l drop tanks): altitude 10.000 m, 460-480 km/h IAS	nm / km	944 / 1749
Maximum range (with 2x600 l drop tanks): altitude 10.000 m, 440-460 km/h IAS	nm / km	1199 / 2220
Maximum endurance (w/o drop tank): altitude 10.000 m, 330-350 km/h IAS altitude 5.000 m, 330-350 km/h IAS	hour.min	2.05 1.45
Maximum allowed operational load factor	G	8
Load factor when plane is damaged	G	12
<b>DIMENSIONS</b>		
Length	ft-in / m	32.94 / 10.04
Width (wingspan)	ft-in / m	33.07 / 10.08
Height to fin	ft-in / m	12.14 / 3.7
Wing sweep	deg	35
Main wheel track	ft-in / m	12.5 / 3.81
Main wheel base	ft-in / m	10.43 / 3.18
<b>WEAPONS</b>		
23 mm machine guns	number guns x number rounds	2 x 80
37 mm machine gun	number guns x number rounds	1 x 40
Bombs	number x caliber (kg)	2 x 100

### 2.2.2. Aircraft dimensions

See [Figure 2.1](#) for dimensions of the MiG-15bis.



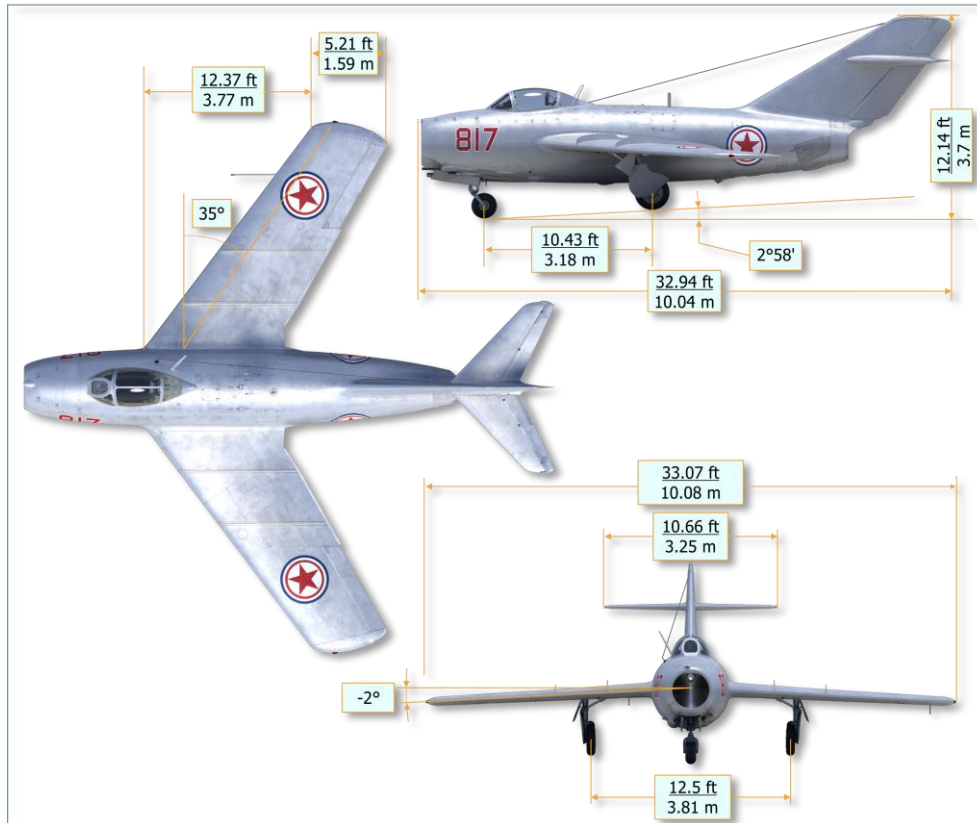


Figure 2.1. MiG-15bis dimensions



**3**

**AIRCRAFT  
AND ENGINE DESIGN**

## 3. AIRCRAFT AND ENGINE DESIGN

### 3.1. Aircraft Design

The MiG-15bis is a single-seat fighter powered by a single Klimov VK-1 engine which provides a static thrust of 2700 kg and contains a series of modifications that improve aircraft performance. The aircraft is a cantilever all-metal structure mid-wing monoplane with a swept wing and empennage. The turbojet VK-1 engine is located in the rear fuselage behind the wing. Air is allowed to enter the engine through an air intake in the front fuselage. The landing gear is of the tricycle type. The main gear is retracted into the wing, and the nose gear is retracted into the fuselage.

#### 3.1.1. Fuselage

*THE FUSELAGE* is designed as a metal semi-monocoque structure consisting of two parts. The rear part of the fuselage is attached to the forward part of the plane using assembly points on the wing. The forward fuselage contains a pressurized cockpit. Under the cockpit there is a hatch for an extendable armament undercarriage.

*THE FORWARD FUSELAGE* houses the forward fuel tank, nose landing gear in retracted position, pressurized cockpit, extendable armament undercarriage, and various equipment including batteries, oxygen tanks, etc.

*THE REAR FUSELAGE* hosts the VK-1 engine with supplementary equipment, an exhaust nozzle, the rear fuel tank, empennage control rods, and air brakes.

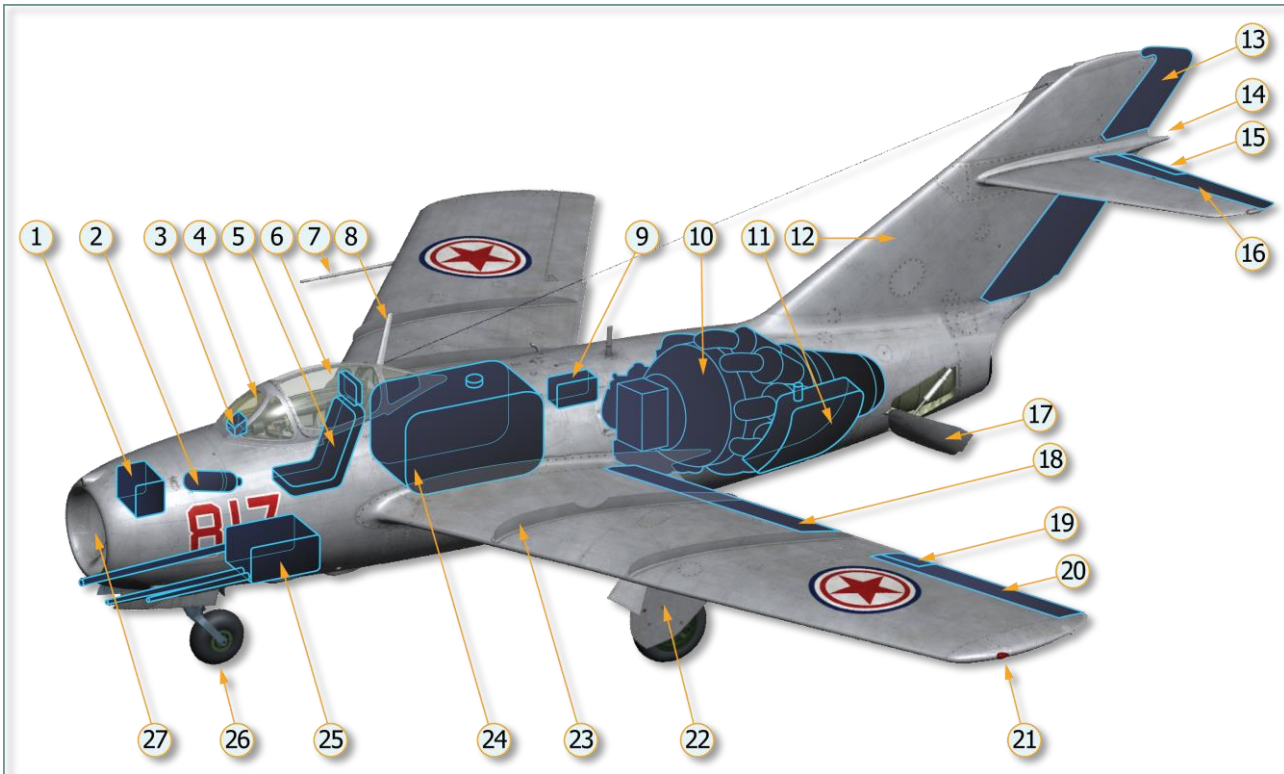


Figure 3.1. General assembly of the MiG-15bis

1. Battery
2. Oxygen tank
3. ASP-3N automatic gunsight
4. Armored windshield
5. Pilot's ejection seat
6. Sliding portion of canopy
7. Pitot tube
8. Antenna
9. Hydraulic fluid tank
10. VK-1 engine with gearbox
11. Rear fuel tank
12. Vertical stabilizer
13. Rudder
14. Tail navigation light
15. Elevator trim tab
16. Elevator
17. Air brake
18. Flap
19. Aileron trim tab
20. Aileron
21. Left wingtip navigation light
22. Main landing gear
23. Wing fence
24. Forward fuel tank
25. Extendable armament undercarriage
26. Nose gear
27. Nose cone with headlight

Several aircraft mechanisms (landing gear, flaps, air brakes) are actuated by the hydraulic system (5.4) which consists of a hydraulic pump, a tank with hydraulic fluid, a hydraulic accumulator and a relief valve. The main fuel tanks are located in the fuselage behind the cockpit (see 5.3).

The aircraft can carry two drop tanks with a capacity of 300, 400 or 600 liters each. They are attached under the wing and can be dropped in the air ("jettisoned"). Instead of the tanks, two 100 kg bombs can be carried under the wing. The aileron control system has a hydraulic actuator of the BU-1 type installed in the right wing. The hydraulic actuator is powered by its own hydraulic system (5.5). Air brakes (3.1.4), located in the tail part of the fuselage, are opened by the hydraulic actuators controlled by the electromagnetic valve from the cockpit.

*THE ARMAMENT* of the aircraft (5.8) includes one 37 mm N-37D cannon and two 23 mm NR-23 cannons. The cannons are located on the forward fuselage: two NR-23 cannons on the left side and one N-37D cannon on the right side. Cannons are mounted on the extendable undercarriage. The ASP-3N automatic gunsight is installed in the cockpit.

The aircraft *ARMOR PROTECTION* consists of the armored windshield, two armored 10 mm panels, installed in front of the cockpit and ammunition boxes, and an armored headrest on the pilot seat.

The aircraft also carries the RSI-6 shortwave transceiver radio set and equipment for instrument landing.

### 3.1.2. Canopy

The canopy hermetically closes the cockpit. For opening, the canopy is moved backwards. The canopy consists of the forward fixed part and a movable part sliding on rollers on three tracks. The fixed part is a front shield made of armored 64 mm thick glass.



**Figure 3.2. Closed (left) and opened (right) canopy**

The movable part of the canopy has two layers of glass: the outer layer is 8 mm thick and the inner layer is 4 mm thick. The space between the layers is filled with dry air. From outside, the canopy is opened with a handle located on the canopy's left-side lock axis.

The canopy is opened with the left or right canopy handle



and closed by opening the rear lock with the



upper, aft canopy handle. Opening and closing the canopy can be toggled with the keyboard command **[LCtrl + C]**.

The canopy is equipped with a jettison system connected with the seat ejection control. The canopy can be jettisoned only from the closed position, regardless of whether the cockpit is pressurized or not. The jettison control is mechanical.

The canopy jettison mechanism consists of the jettison handle on the right armrest of the pilot seat, two columns with bellcranks, transfer mechanism, two rods and three jettison locks.



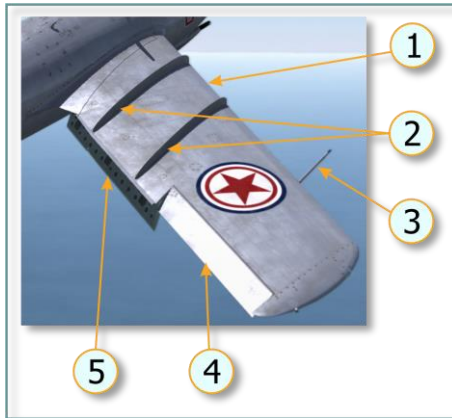
**Figure 3.3. Canopy jettison handle**

To jettison the canopy, push the jettison handle forward **[RCtrl + J]**.

The pilot seat has an ejection mechanism. To eject the seat, press the ejection button on the armrest **[LCtrl + E]** (three times). The seat can be ejected only after the canopy jettison.

### 3.1.3. Wing

The wing of the MiG-15bis consists of two detachable panels (left and right) with duralumin mainframe and skin. The wing is swept to an angle of  $35^\circ$ , has wing fences<sup>1</sup> (2), ailerons (4) with internal aerodynamic compensation and flaps (5). V-of-Wing is  $-2^\circ$ . The flaps extend backwards and down.



1. Right wing
2. Wing fences
3. Pitot tube
4. Aileron
5. Flap

Figure 3.4. MiG-15bis wing

#### *Ailerons*

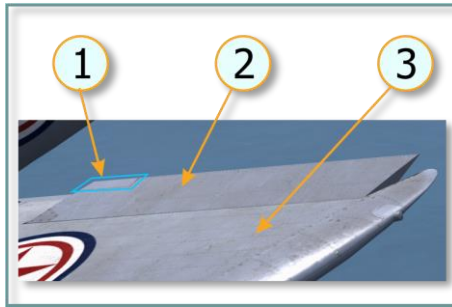
The length of the aileron is 1.8 m. The aileron chord is 18.75% of the wing chord. The overall area of the ailerons (without compensation) is  $1.01 \text{ m}^2$  which is 4.92% of the wing area.

The aileron deflection axis passes at a distance of 18% of the chord from the wing trailing edge. For maneuvering, the aileron deflection angle is  $\pm 15^\circ$ . In the middle of the leading edge, the aileron has a flat protrusion which works as aerodynamic compensation of the aileron. On the edge of the protrusion, there are two steel plates which work as weight compensation of the aileron.

---

<sup>1</sup> The aerodynamic wing fences prevent the airflow shift (its boundary layer) from the fuselage to the wing tip.





1. Aileron trim tab
2. Left aileron
3. Left wing

**Figure 3.5. MiG-15bis ailerons**

Each aileron is attached to the wing at two attachment points and controlled by the lever that during deflection stays within the contour of the wing. The lever is deflected by the hydraulic actuator piston rod when roll is initiated by the stick.

The ailerons have controllable trim tabs (1).

A trim tab is a small tab on the left aileron which deflects from the aileron plane thereby creating a small aerodynamic force helping to maintain the required aileron deflection angle without additional forces on the control stick. Direct mechanical connection between the ailerons makes it sufficient to have only one trim tab on the left aileron to hold both ailerons at the required deflection angle.

The operation of the ailerons in the [flight control system](#) is described [here](#).

### ***Flaps***

The flaps (Figure 3.6) are installed on the wing between the ailerons and the fuselage. During takeoff, they are extended to an angle of 20° in order to provide extra lift force. For landing, they are extended to 55°.



**Figure 3.6. MiG-15bis with extended flaps**

The span of the flap is 2.65 m, the chord is 0.481 m. For extension, the flap moves downward and simultaneously backward to the rear edge of the wing. The maximum deflection angle for the flap is  $55^\circ$ . While deflecting down, the flap is also moving backward by 0.2 m, i.e. to 41% of its chord. The flaps have a sliding rotation axis.

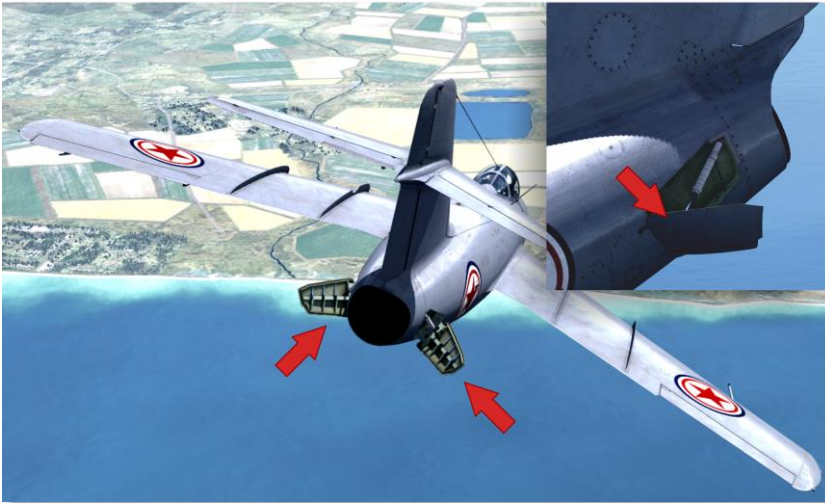
The flaps are extended by two hydraulic actuators installed in the wing. The translational motion of the actuator is transferred to the control sector. Through a system of rods and levers, the rotation of the sectors is transferred to the flaps, which slide on the guiding carriages and thereby move backwards and deflect downwards.

In the retracted position, the flaps are held by three locks connected with each other by cables and rods. The locks are opened by special hydraulic actuators installed successively in the main actuator [hydraulic system](#) of the flaps. In cases of emergency, the flaps can also be extended with the help of the emergency pneumatic system (see [5.7.2](#)).

The operation of the flaps in the [flight control system](#) is described [here](#).

### 3.1.4. Air brakes

The aircraft has air brakes (speed brakes) on both sides of the rear fuselage (Figure 3.7). In the tail section of the fuselage there is an air brake electromagnetic control valve.



**Figure 3.7. Extended speedbrakes**

The air brakes are located symmetrically on the left and right sides of the rear fuselage. Extension and retraction is driven by two hydraulic actuators powered by the [utility hydraulic system](#) and controlled from the cockpit by the button on the [flight control stick](#) or by the switch on the left side panel. To synchronize opening angles of both air brakes, there is a connecting tube with a system of levers. Thus, even if the two hydraulic actuators operate at different speeds, both air brakes will be opened to the same angle within the same amount of time. The opening angle of the speed brakes is 55° from the original position.

Keep in mind that the full extension of the air brakes takes approximately 3 seconds, while the retraction takes approximately 4 seconds.

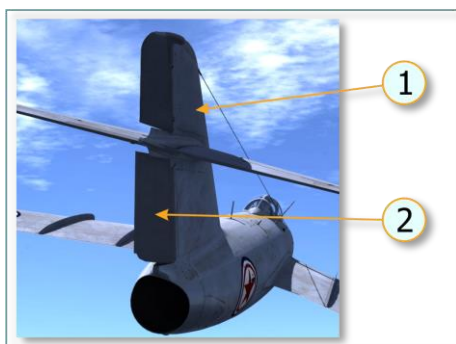
The model has air brakes of increased size – 0.8 m<sup>2</sup>. The operation of the air brakes in the flight control system is described [here](#).

### 3.1.5. Empennage

The empennage of the MiG-15bis is single-fin, swept back. The sweep angle of the horizontal tail is  $40^\circ$  and that of the vertical tail is  $54^\circ 50'$ . The profile of the horizontal and vertical tails is symmetrical. The horizontal stabilizer setting angle is parallel to the fuselage waterline.

However, the forward stabilizer-to-fuselage attachment point has a fitting allowing changing the horizontal stabilizer setting angle on the ground from  $-2^\circ$  to  $+2^\circ$ .

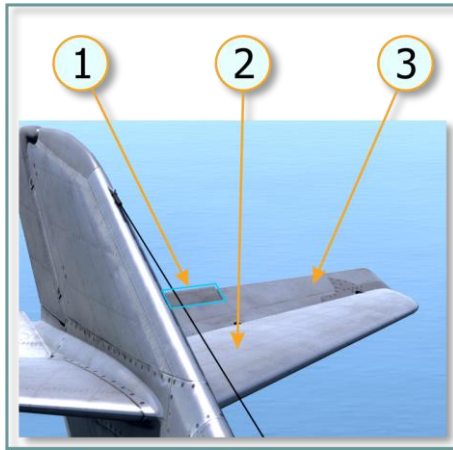
*THE VERTICAL EMPENNAGE* consists of the vertical stabilizer (1) and the [rudder](#) (2), the latter being a flight control surface. The rudder does not have a trim tab and deflects to the right and to the left by  $20^\circ$ .



1. Vertical stabilizer
2. Rudder

**Figure 3.8. Vertical empennage**

*THE HORIZONTAL EMPENNAGE* consists of the horizontal stabilizer and the [elevator](#), the latter being a flight control surface.



1. Elevator trimmer tab
2. Horizontal stabilizer
3. Elevator

**Figure 3.9. Horizontal empennage**

All the flight control surfaces are controlled mechanically (without hydraulic actuators). The limit for the upward deflection is  $32^\circ$ , for the downward deflection it is  $16^\circ$ . The elevator (3) has a trim tab (1).

A trim tab is a small tab on the elevator which deflects from the elevator plane, thereby creating a small aerodynamic force helping to maintain the required elevator deflection angle without additional forces on the control stick.

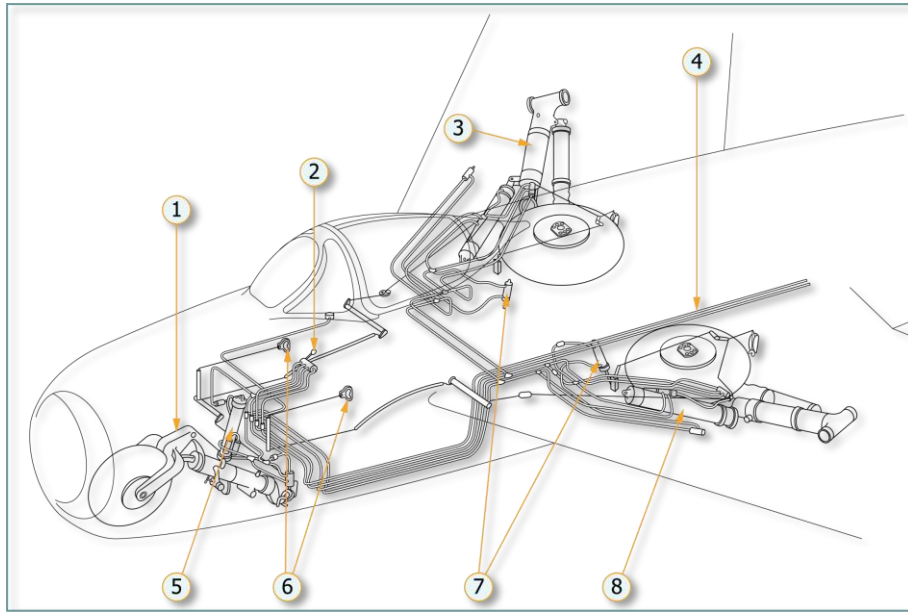
### **3.1.6. Landing gear**

The aircraft has a tricycle landing gear.



**Figure 3.10. MiG-15bis with extended gear**

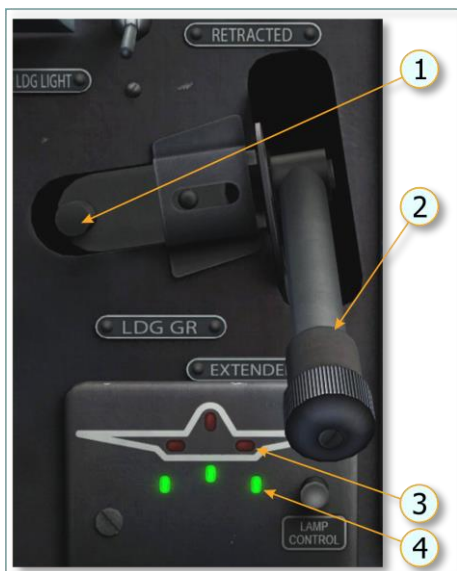
The landing gear extension and retraction control is hydraulic, i.e. powered by the [utility hydraulic system](#).



**Figure 3.11. Landing gear and related systems**

1. Nose gear
2. Landing gear control handle
3. Main landing gear
4. Line to hydraulic fluid tank
5. Nose gear retraction actuator
6. Landing gear uplock emergency release handles (landing gear emergency extension handles)
7. Landing gear door actuator
8. Main landing gear retraction actuator

The landing gear is extended and retracted by the control handle (2) in the cockpit (Figure 3.12), located on the [instrument panel](#). [Emergency extension](#) is pneumatic.



1. Landing gear lever lock (to prevent unintentional gear retraction, when plane is on the ground)
2. Landing gear extension / retraction handle
3. Gear retracted red signal lamps
4. Gear extended green signal lamps

**Figure 3.12. Landing gear extension/retraction handle and indication of retracted/extended position**

The landing gear extension/retraction process is indicated by lamps of green (4) and red (3) (Figure 3.12) colors and by mechanical pointers on the wing (outside) (Figure 3.13).



**Figure 3.13. Mechanical indicators on the wings when landing gear is fully extended: left, nose, right**

The main landing gear with the doors attached to the wing retracts into the wing towards the fuselage.





The landing gear niche is closed by two doors attached to the landing gear and one door attached to the wing. The doors are actuated by the [utility hydraulic system](#), but use dedicated hydraulic actuators (not those used by the landing gear). In the extended position, the landing gear is held by the extension/retraction actuators, in the retracted position by the bomb-holder type locks.

The retraction of the landing gear is done by the hydraulic actuator which opens the hydraulic lock that locks the gear in the extended position (i.e. in case of hydraulic system failure after gear extension, it will be impossible for the landing gear to retract inadvertently). In the retracted position, the landing gear is locked by a hydromechanical lock. The inner volume of the main gear leg is used as compressed air storage, which is used in case of emergency extension.

The retraction and extension of the landing gear is controlled by the pilot from the cockpit by moving up or down the landing gear lever located on the left side of the instrument panel. The wheels of the main gear have pneumatic shoe type brakes.

The nose gear is retracted forward into the niche in the fuselage.



After retraction, the landing gear niche is closed by two doors.

To put the nose landing gear into neutral position during retraction, there is a nose wheel steering mechanism.

The main landing gear wheels' brake automatically (to avoid "fighting" with gyroscopic momentum), when the landing gear lever is set in УБРАНО (RETRACTED) position. Brake pads remain latched until the lever is not set in neutral position. One has to remember that when brake pads are latched (i.e. lever is not in neutral position), air from the brake system bleeds slowly.

### ***Landing gear emergency release***

To safeguard the landing gear operation, its extension system is backed by the pneumatic emergency extension system. In case of malfunction of the hydraulic system, the landing gear can be extended by the emergency extension system which opens an air valve from which there is an independent line to the landing gear emergency extension valve.



**Figure 3.14. Pressure gauge and landing gear emergency extension valve handle on the right panel**

*FOR LANDING GEAR EMERGENCY EXTENSION:*

1. Manually open the gear locks (mechanically, by pulling the cable), [|LShift + Space|](#), [|RShift + Space|](#).



2. Move the landing gear lever to the **ВЫПУЩЕНО (RELEASED)** position.
3. Open the air valve by rotating the handle with the mouse wheel to initiate pneumatic extension of the landing gear ([Figure 3.14](#)), [|RAlt + RShift + G|](#). In this position, the hydraulic fluid will flow from the opposite bay of the retraction actuator to the tank through the landing gear valve (connected with the handle).

## 3.2. Engine and Related Systems

### 3.2.1. General design and layout

Unlike the MiG-15, the MiG-15bis has the VK-1 engine instead of the previously installed Rolls-Royce Nene I (II) engine.

Although the VK-1 ("Vladimir Klimov-1") was based on another design, nevertheless it was completely designed and manufactured by the Klimov Design Bureau. The engine is located in the rear fuselage. The engine axis coincides with the airplane axis. The exhaust part of the engine has an extensive pipe connected to the engine by a special movable joint. The extensive pipe ends with a jet nozzle. The air for the engine is taken from the front air intake.

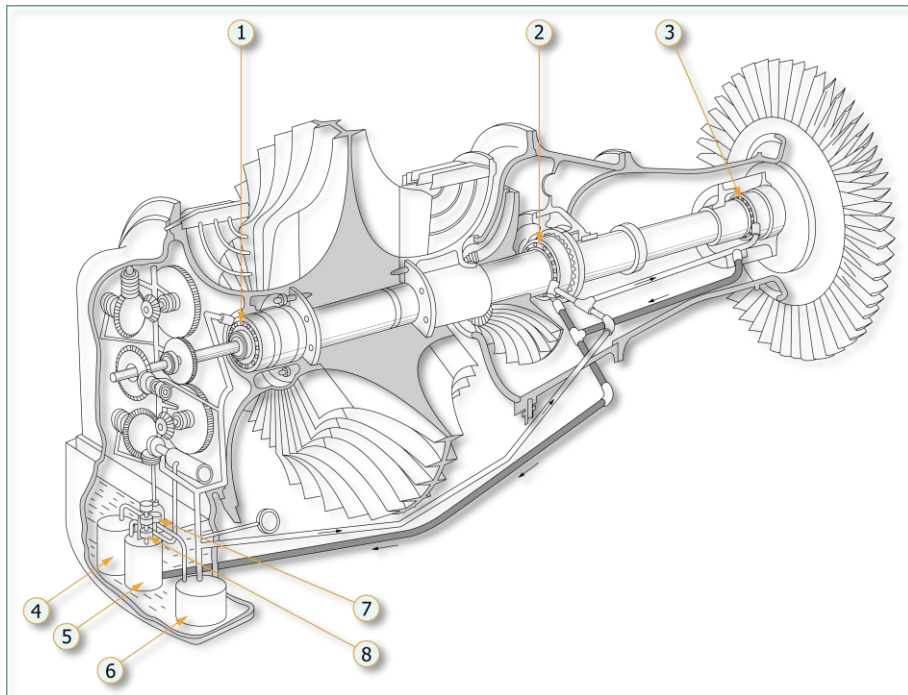
The VK-1 is a single shaft turbojet engine with a single stage double sided radial flow compressor, nine individual tubular combustion chambers seated uniformly on the outer part of the compressor housing and a single stage turbine. The engine operation is ensured by the fuel system, engine automatics, a system of fuel tanks, oil system, and a fire extinguishing system. The main engine characteristics are listed in Table 3.1.

**Table 3.1**

<b>Characteristic</b>	<b>Value</b>
Maximum thrust, kg	2700
Specific fuel consumption, kg/(kgf*h)	1.07
Airflow rate, kg/s	48.2
Compression ratio, times	4.2..4.5
Tc max, K	1170
Length, mm	2640
Diameter, mm	1270
Dry weight, kg	870
Service life, h	200

### 3.2.2. Engine oil system

The engine oil system is mounted fully on the engine and does not have any elements on the aircraft. The engine oil system does not require a heat exchanger.



**Figure 3.15. VK-1 oil system**

- |                                       |                                      |
|---------------------------------------|--------------------------------------|
| 1. Forward bearing                    | 5. Oil filter at scavenge pump inlet |
| 2. Middle bearing                     | 6. High pressure oil filter          |
| 3. Turbine bearing                    | 7. Scavenge oil pump                 |
| 4. Oil filter at injection pump inlet | 8. Injection oil pump                |

As a grease oil, the engine uses the GOST 382-43 oil with a 0.05-0.1% additive of stearin acid.

The box of oil pumps attached to the lower flange of the gearbox serves as an oil tank and can take approx. 7 liters of oil. This box also serves as a housing for two oil pumps, three filters and a pressure reducer valve.

### 3.2.3. Engine operation

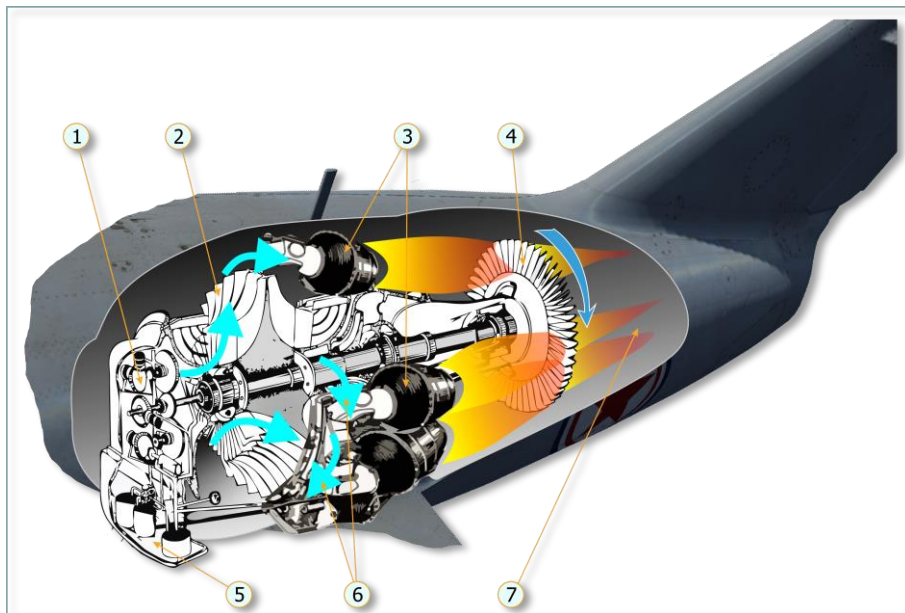
The aircraft has an air intake on the front of the fuselage. Through the air intake, the air comes to the engine by two channels, on the left and on the right from the cockpit. Then the air goes to the radial-flow compressor, [Figure 3.16](#) (2), where it is compressed 4.2 to 4.5 times by centrifugal forces (6). After that the compressed air from the outer portion of the compressor rotor

wheel is supplied to each of the nine individual combustion chambers (3) where it is mixed with sprayed fuel.

This mixture is being burned continuously during engine operation after the engine start. On the output from the combustion chamber, hot gases spend a part of their energy to maintain rotation of the compressor which is mounted on the same shaft with the single-stage turbine (4). Now hot gases enter the expanding exhaust pipe (7) where they are accelerated and forced to form a jet plume (jet thrust).

The turbine is rotated by the energy of the hot gases passing through it and mechanically transfers the rotation to the compressor and the elements of the gearbox.

[Figure 3.16](#) depicts the VK-1 engine, designed by the V. Klimov Design Bureau and located in the rear fuselage of the MiG-15bis:

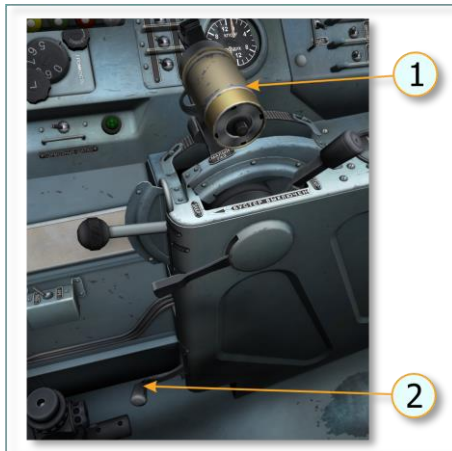


**Figure 3.16. Layout and operation of the VK-1 engine**

1. Gearbox
2. Centrifugal compressor
3. 9 can combustion chambers
4. Compressor turbine
5. Engine oil system components
6. Compressed air supplied to the combustion chambers
7. Jet pipe and exhaust nozzle (not shown here).

### 3.2.4. Engine controls

The engine control system consists of the *ENGINE THROTTLE* and the *SHUT-OFF VALVE LEVER* (hereinafter referred to as the "shut-off valve"). Both are located on the [throttle console](#) on the left side of the cockpit.



1. Engine throttle
  2. Shut-off valve lever
- For other elements in the figure see section [throttle console](#)

The engine throttle is connected with the butterfly valve lever on the right side of the engine by a system of rigid rods.

The butterfly valve lever has two positions: one for engine start on the ground and one for restart in the air.

The shut-off valve disconnects the fuel flow in case of engine shutdown or engine fire.

The shut-off valve itself performs the function of opening/closing the fuel line for the engine. It is installed on the left side of the engine.

The engine is controlled by the throttle from the cockpit.

By moving the throttle forward the pilot affects the fuel supply to the combustion chamber. More fuel to burn causes the increase of the exhaust gas energy which increases the rpm of the compressor turbine and the air flow rate, so the combustion chamber is now "ready" to take more fuel. It is the "readiness" of the combustion chamber to take a certain amount of fuel based on the minimum possible amount of air for a stable burning of this fuel that requires that the throttle be moved smoothly. A movement of the throttle

accelerates the engine. The acceleration continues until a certain moment. This moment is directly connected with the position of the metering pin, while the position of the metering pin is connected with the position of the throttle. When the throttle is moved backward, the engine elements work in a similar way. Therefore, the throttle should never be moved abruptly (no quicker than 1.5 seconds for a full stroke).

But it is not only the pilot who affects the engine operating mode, but also airspeed and a flight altitude.

When the speed increases, air compression before the compressor can either deteriorate or improve (it depends on the current speed value and flight altitude and is related to losses in the air flow channel). This either helps the compressor to compress the air or hinders it and therefore requires a change in the fuel supply to achieve the needed air compression.

As altitude grows and the air density decreases, the compressor requires more energy (part of the burn-off fuel mass) to achieve the needed air compression.

Ultimately, both the airspeed and the altitude affect the air pressure at the compressor inlet. Therefore, when they change, the amount of fuel to be burned must be adjusted.

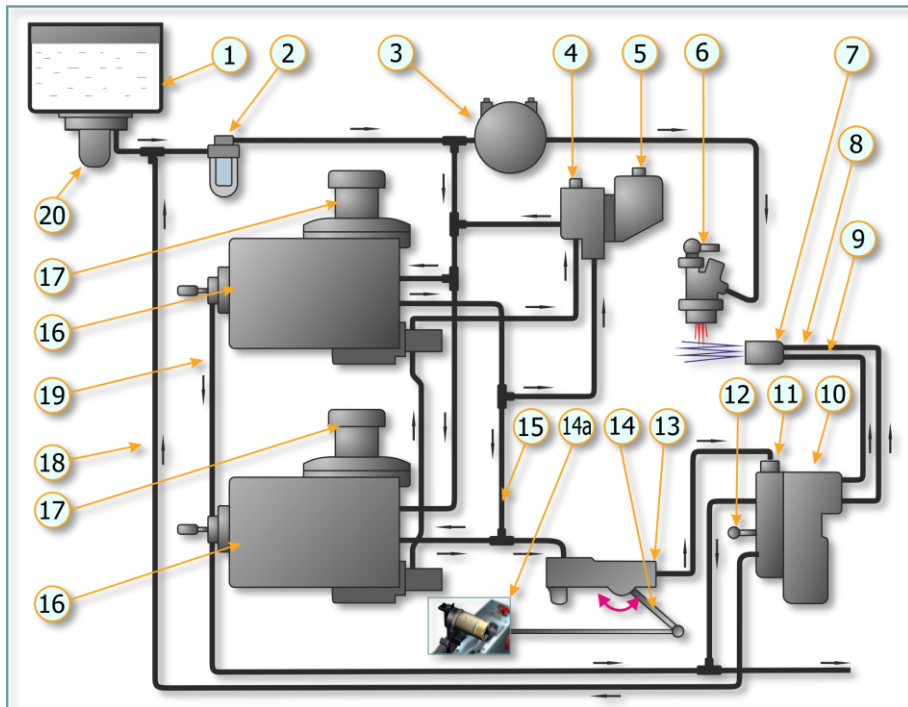
The function of continuous adjustment of the amount of fuel supplied into the combustion chamber depending on the airspeed and altitude is performed by the *ENGINE FUEL AUTOMATICS*.

### ***VK-1 engine fuel automatics***

The engine fuel automatics supplies combustion chambers with a certain amount of well atomized fuel needed for normal engine operation. Fuel supply is controlled by fuel pumps. The pilot can set the amount of fuel to be consumed by the engine using the throttle handle, precise fuel dosage is controlled by special regulators.

Interaction of the various fuel automatics units is shown in Figure 3.17.





**Figure 3.17. VK-1 fuel automatics**

- |   |   |
|---|---|
| 1. Fuel tank                                    | 12. Shut-off valve lever                |
| 2. Filter                                       | 13. Fuel control valve                  |
| 3. Starting fuel pump                           | 14. Main fuel regulator                 |
| 4. Barostat isolation valve (servo)             | 14a. Throttle                           |
| 5. Barostatic regulator                         | 15. High pressure line                  |
| 6. Igniter                                      | 16. High pressure pump                  |
| 7. Fuel nozzle                                  | 17. RPM governor                        |
| 8. Large slot manifold (operating)              | 18. Fuel bypass line                    |
| 9. Small slot manifold (starting and operating) | 19. Fuel drain line                     |
| 10. Flow divider                                | 20. Fuel tank boost pump (forward tank) |
| 11. Shut-off valve                              |   |

By a booster pump (20) fuel from the tank (1) is fed via a low-pressure line through a filter (2) into two high pressure pumps (16) working in parallel (driven from engine gearbox). From the pumps (16), fuel, via a high-pressure line (15), is fed through the fuel control (13) and shut-off valves (11) to the flow divider (10) and further through large slot manifold (8) and small slot

manifold (9) to double-channel nozzles. It's worth mentioning that the amount of fuel pumped by the pumps (16) is always bigger than engine needs at current RPM, therefore fuel automatics regulators partially open fuel return line immediately after engine start, ensuring stability in engine operation.

The VK-1 *SHUT-OFF VALVE*, together with distribution valve, is implemented in the same unit. Shut-off valve is controlled by the [lever](#) (12). For the engine to operate, the shut-off valve has to be opened. In this case fuel has free access to the distribution valve and engine nozzles. To stop the engine, it is necessary to close the shut-off valve, thus closing fuel access to the nozzles. At the same time shut-off valve commutes high pressure line (15), through the fuel return line, with low pressure line and flow divider and manifolds (8) and (9) with drain line, which drains remaining fuel into the atmosphere. Through this line fuel leaked through pumps' drive shaft gasket seals is drained.

With help of the throttle (14a) through various rods pilot affects *FUEL CONTROL VALVE* (13) of the main fuel regulator (14), changing the amount of fuel supplied to the fuel nozzles (7), and thereby selecting the desired engine operation mode. To smooth drastic change in fuel consumption in the line caused by throttle movement and to reduce engine surge probability, a throttle response regulator (hydraulic retarder) is installed behind the throttle valve. It is a separate device and not shown on the schematic.

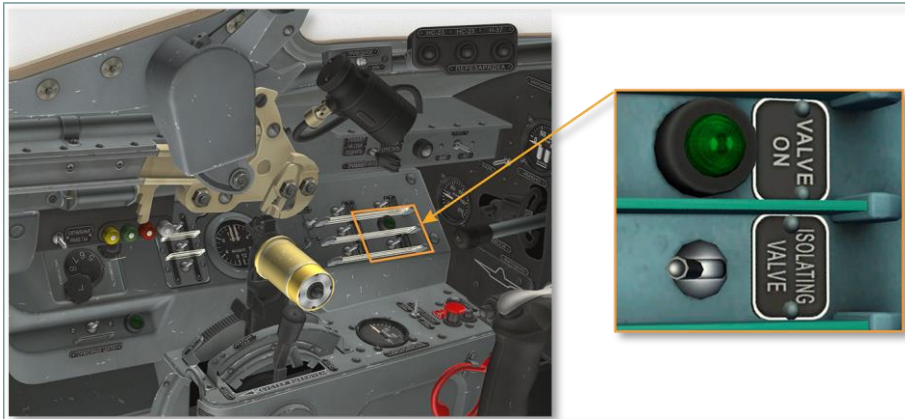
Every pump (16) has a maximum RPM governor (17).

To ease engine startup, igniters (6) are used. Each igniter consists of a start nozzle and an electrical spark plug. During engine startup, the starting fuel pump (3), which is driven by an electrical motor, supplies the start nozzles with fuel, which is being ignited by the electrical spark plugs. Formed because of that torch ignites fuel fed from main fuel nozzles (7). Later, after fuel ignition in the combustion chambers, electrical spark plugs are not involved in combustion sustaining.

***BAROSTATIC REGULATOR OPERATION.*** As mentioned above, with change of altitude or flight speed air pressure at the compressor inlet changes as well and to take into account these changes, a barostatic regulator (5) is used. A barostat aneroid (sensitive element) is located at the compressor entrance and exposed to air flow and servo, which is actually responsible for fuel regulation, is included in the high-pressure fuel line. The barostat membrane moves the execution unit lever under air pressure and consequently moves piston in isolation valve (4). This piston reduces or increases the amount of fuel being drained from the high-pressure line (15) into the low-level line. Thus, due to automatic fuel pressure regulation optimal air/fuel balance in combustion chambers is always kept. The fuel consumption regulator is a static device, because regulating element (inclined washer) position change is connected with

corresponding fuel consumption change (fuel pressure). The fuel consumption regulator is affected by the static regulation error.

In case the barostatic regulator malfunctions, it is possible to turn it off and thus exclude it from the automatic regulation control system. It is done with a solenoid (electrical magnet) working from 27 VDC. Turning off the barostat is performed by switching on the automatic circuit breaker on the left electrical panel. When the solenoid operates (barostat turned off), the signal lamp is on, Figure 3.18.



**Figure 3.18. Isolation valve automatic circuit breaker and corresponding signal lamp**



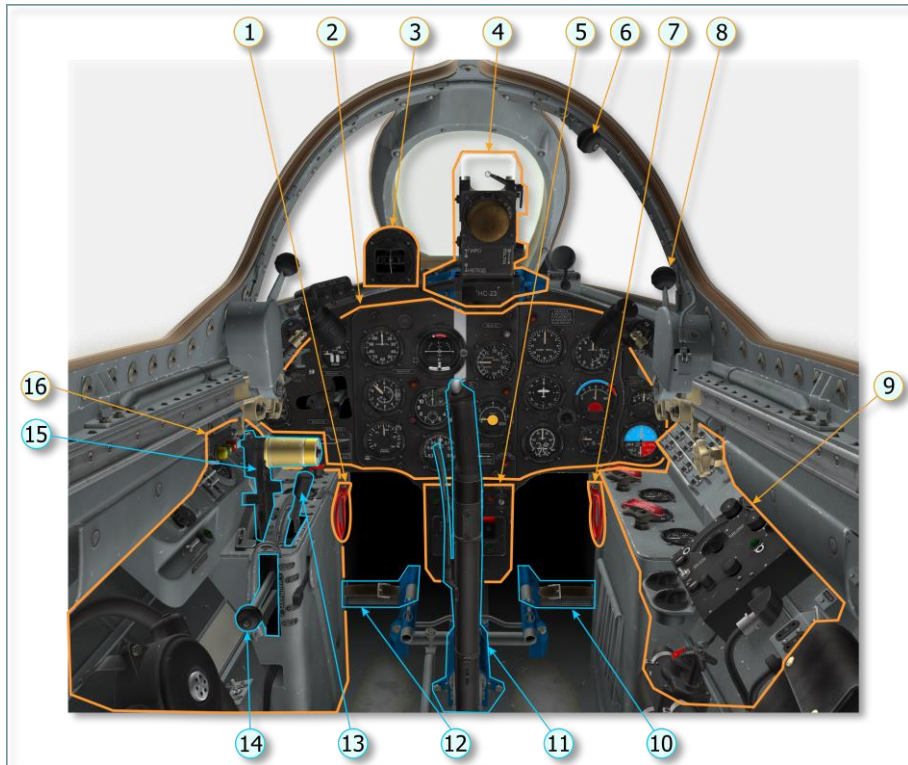
4

**COCKPIT**

## 4. COCKPIT

The cockpit (Figure 4.1) accommodates the aircraft and engine controls, instrument panel, armament control panel, gunsight, left panel (with instruments and equipment) and right panel (with instruments and equipment).

In addition, some equipment is installed on the rear wall of the cockpit.



**Figure 4.1. MiG-15bis cockpit**

- |   |   |
|---|---|
| 1. Left main landing gear emergency uplock release handle | 10. Right <a href="#">rudder</a> pedal  |
| 2. <a href="#">Instrument panel</a>                       | 11. <a href="#">Flight control stick</a>  |
| 3. Magnetic compass                                       | 12. Left <a href="#">rudder</a> pedal   |
| 4. <a href="#">ASP-3N gunsight</a>                        | 13. Aileron hydraulic actuation control handle ( <a href="#">Shut-off valve</a> ) |

5. [Armament control panel](#)
6. Canopy closing handle
7. Emergency right and nose gear release handle
8. Canopy opening handle
9. [Right side](#) (with instruments and switches)
14. [Flaps extension/retraction handle](#)
15. [Engine throttle](#)
16. [Left side](#) (with instruments and switches)

#### **4.1. Aircraft and engine controls**

In the 1950s, the system of classification the aircraft systems and elements was different from the one we use today. According to the old system, together with the flight control stick, engine throttle, pedals, and trim tabs, the flaps and speed brake controls were also included into the flight control system.

The aircraft flight controls are a part of the aircraft [flight control system](#). On the MiG-15bis, the flight controls are the *HAND AND PEDAL CONTROLS, ELEVATOR AND RUDDER TRIM TAB CONTROLS AND FLAPS AND SPEED BRAKE CONTROLS*.

A central unit of hand and pedal controls located on the cockpit floor accommodates the flight control stick, pedals, brake system actuator, and aileron control crank.

The areas where control rods go out of the cockpit are hermetically sealed.

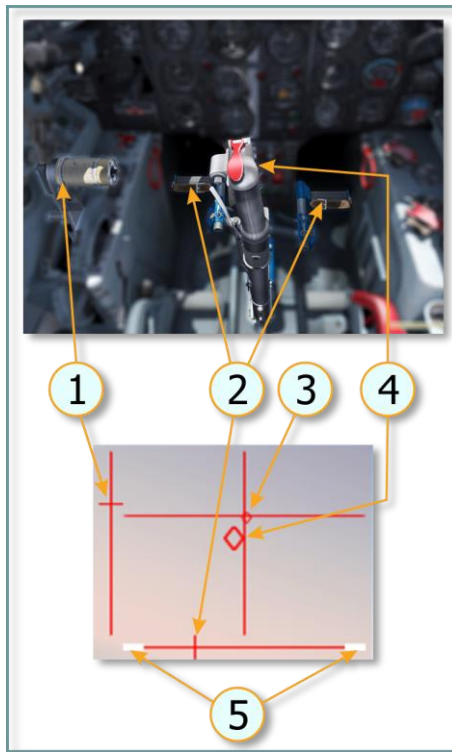


Figure 4.2. Main flight and engine controls and their position indication panel

Location in the cockpit and position indication:

1. Engine throttle (right part of line) and [Shut-off valve lever](#) (left part of line)
2. Pedals
3. Trim tab
4. Flight control stick
5. Indication of braking force on the wheels. It will look like this if brake lever is pushed all the way towards the stick:

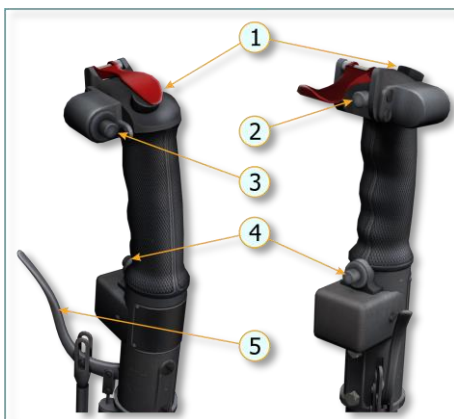


Return to [13.3.1](#)

#### 4.1.1. Flight control stick

The flight control stick is shown in [Figure 4.3](#).

Besides the flight control function, the stick has buttons and levers to control other systems and equipment.

**Flight control stick:**

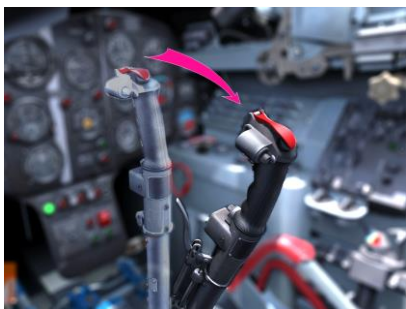
1. N-37D gun firing button with a safety cover
2. NR-23 gun firing button
3. Speed brake extension button
4. Bomb and fuel tank jettison button (can have a safety cap)
5. Brake control lever

**Figure 4.3. Flight control stick**

When piloting the aircraft from the cockpit, you can activate the control position indicator by using the key combination [[RCtrl](#) + [Enter](#)].

Hand control is forward, backward, right, and left movements of the flight control stick that control the elevator and ailerons; pedals are used for rudder control.

*ELEVATOR CONTROL* (pitch control) is achieved by pushing the flight control stick forward and pulling backward (in the figure, the flight control stick is pulled back):



For the design description see [here](#).

For the operation of the flight control system see [here](#).



*AILERON CONTROL* (roll control) is achieved by moving the flight control stick to the left and to the right (in the figure, the flight control stick is moved to the left):



For the design description see [here](#).

For the operation of the flight control system see [here](#).

#### 4.1.2. Pedals

*RUDDER CONTROL* to the left and to the right is achieved by pedal inputs (in the figure, the left pedal is pressed forward):



For the design description see [here](#).

The design and features of the flight control system are described in section [5.1.3](#).

### 4.1.3. Engine throttle handle

The engine throttle handle (Figure 4.4) is another element of the [flight control system](#). It is located on the throttle console on the pilot's left [control pedestal](#). It controls thrust of the VK-1 jet engine.

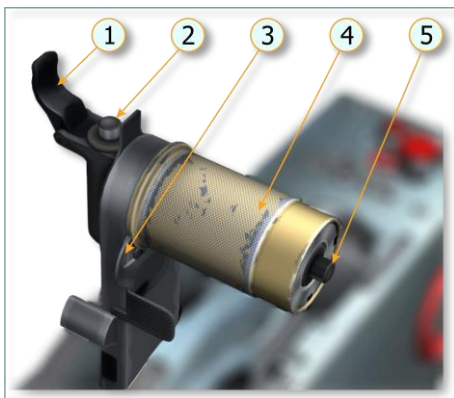


Figure 4.4. Engine throttle handle

Engine throttle handle:

1. Safety cover for the engine starter button
2. Engine starter button
3. ASP-3N gunsight target range twist lock
4. ASP-3N gunsight target range twist
5. RSI-6K radiotransmitter button

The engine is controlled by moving the throttle handle forward (to increase thrust) and backward (to reduce thrust). To shut the engine off or to open full access for the fuel to the distribution valve and engine nozzles, there is a [shut-off valve](#), located on the control pedestal.

For the description of the engine design and features see section [3.2](#).

### 4.1.4. Flaps control

For the design description see [here](#).

Operation of the flaps in the flight control system is described [here](#).

### 4.1.5. Speedbrake control

For the design description see [here](#).

Operation of the speedbrakes in the flight control system see [here](#).

## 4.2. Instrument panel

The instrument panel is shown in Figure 4.5.



Figure 4.5. MiG-15bis instrument panel

- |  |  |
|--|--|
| 1. 55° flaps extension angle signal lamp                         | 17. <a href="#">VA-340</a> volt-/amperemeter                     |
| 2. <a href="#">VD-17</a> altimeter                               | 18. <a href="#">UVPD-3</a> cabin altitude and pressure indicator |
| 3. <a href="#">KUS-1200</a> airspeed indicator                   | 19. <a href="#">EM-10</a> electrical fuel pressure gauge         |
| 4. <a href="#">Radio marker beacon</a> fly-over lamp             | 20. <a href="#">Fast compass slave button</a>                    |
| 5. <a href="#">Extend landing gear warning lamp</a>              | 21. <a href="#">EMI-3R</a> electrical motor indicator            |
| 6. <a href="#">AChS-1</a> cockpit chronograph (clock)            | 22. <a href="#">"Second fuel tank empty" warning lamp</a>        |
| 7. <a href="#">AGK-47B</a> attitude indicator                    | 23. <a href="#">Engine start prohibited lamp</a>                 |
| 8. <a href="#">Generator off</a> warning lamp                    | 24. <a href="#">KES-857</a> fuel meter                           |
| 9. <a href="#">VAR-75</a> vertical velocity indicator            | 25. <a href="#">Mach number indicator</a> , M=0,95               |
| 10. <a href="#">S-13</a> gun camera recording light              | 26. <a href="#">PRV-46</a> radio altimeter                       |
| 11. <a href="#">"300 liters" warning lamp</a>                    | 27. <a href="#">Landing gear hydraulic lever</a>                 |
| 12. <a href="#">Air restart ignition off memo light</a>          | 28. <a href="#">Landing gear control panel</a>                   |
| 13. <a href="#">ARK-5 SUP-7</a> automatic direction finder (ADF) | 29. <a href="#">MK-12</a> oxygen pressure gauge                  |
| 14. <a href="#">DGMK-3</a> gyromagnetic compass indicator        | 30. B-45 landing light switch                                    |
| 15. <a href="#">TE-15</a> electrical tachometer                  | 31. <a href="#">IK-14</a> oxygen indicator                       |
| 16. <a href="#">TGZ-47</a> exhaust gas temperature gauge         |  |

#### 4.2.1. 55° flaps extension angle signal lamp

This lamp, labeled ЗАКРЫЛКИ (FLAPS), illuminates when the flap extension angle reaches 55° (upon closure of the end switch).



#### 4.2.2. VD-17 altimeter

The VD-17 altimeter shows the barometric flight-level altitude in a range of 0 – 17.000 m.



1. QFE (4) setting rotary knob
2. Long arrow indicating hundreds of meters on scale (6)
3. Scale of altitudes of 10-17 km (indicated by short arrow)

4. QFE pressure scale, in mmHg
5. Short arrow indicating kilometers on scales (6) and (3)
6. Scale 0-10 km

The scale spacing on the outer scale is 10 m; that of the inner scale is 1 km. The short arrow indicates the altitude in kilometers, the long arrow indicates the altitude in meters. The altimeter has a pressure scale connected with both arrows and the rotary knob. For the pressure, a QFE value is selected by rotating the knob (1). In the game, the knob is rotated either from the keyboard or by the mouse wheel after pointing the cursor over the knob (1). [Instrument panel](#)

#### 4.2.3. KUS-1200 airspeed indicator

The KUS-1200 is a combined airspeed indicator which indicates the translational speed of the aircraft in the air environment. It simultaneously measures indicated airspeed in a range of 100 to 1200 km/h and true airspeed in a range of 400 to 1200 km/h at altitudes from 0 to 15000 m. In flight, the true airspeed is indicated by the narrow needle.



The KUS-1200 measures the difference between the total and static pressure in flight, i.e. the ram, with allowance for the ambient air density made by an aneroid.

The indicated airspeed is directly proportional to the ram pressure on the pitot tube installed on the right wing. The true airspeed is the speed of the aircraft relative to the static air molecules. The air density decreases with the increase of altitude. It means that to have the same pressure on the pitot probe (to have the same airspeed on the indicator), at a higher altitude a higher speed is required. The pilot does not have to recalculate the airspeed into the true

airspeed, because the device does it automatically with the help of a set of aneroid boxes with control sectors. Eventually, the narrow needle indicates the true airspeed taking into account flight altitude, together with the difference between the total and static pressure.

### [Instrument panel](#)

#### 4.2.4. Radio marker beacon fly-over lamp

This lamp receives a signal from the [MRP-48P](#) marker beacon receiver and illuminates when flying over a radio marker beacon. The light is accompanied by a buzzer sound.



#### 4.2.5. Extend landing gear warning lamp

This lamp illuminates when the flaps are extended while the landing gear is not down.



### [Instrument panel](#)

#### 4.2.6. AChS-1 cockpit chronograph (clock)

The Molnija AChS-1 is an electrically heated aviation chronometer clock that displays the current time of day in hours, minutes, and seconds. It can also be used to measure mission/flight time in hours and minutes, and as a chronometer to measure short periods of time (up to one hour) in minutes and seconds.

The clock is located on the instrument panel and consists of three mechanisms:

- a) time-of-day clock;
- b) flight time indicator;
- c) stopwatch to accurately measure short time periods.



- |  |   |
|--|---|
| 1. Left crown button   | 4. 60-minute stopwatch clock dial         |
| 2. 12-hour mission (flight) time clock dial                            | 5. Outer dial and time-of-day clock hands |
| 3. Mode indicator window<br>(in the figure the flight time is stopped) | 6. Right crown button                     |

The time of day display operates continuously. Flight (mission) time can be activated as desired by pressing the left (red) crown button (1) **|RAlt + RCtrl + RShift + C|**. The stopwatch can be activated as desired by pressing the right crown button (6) **|RAlt + RShift + C|**.

To set the time, first stop the clock by rotating the right crown button (6), labeled ПУСК (START), clockwise **|RCtrl + RShift + .|** when the second-hand points to 12. Then pull the left crown button (1) **|RShift + M|** while holding down the right mouse button, and rotate it counter-clockwise **|LAlt + .|** or clockwise **|LAlt + ,|** to set the desired time. Rotating the right crown button counter-clockwise **|RCtrl + RShift + .|** again resumes clock operation with the new time setting.

Flight (mission) time is indicated on the small scale at the top of the clock face. Flight time mode is indicated by the following three markings inside the mode indicator window (3):

- Red: Flight time is running.
- Red-white: Flight time is stopped.
- White: Flight time is reset (standby).



Press the left crown button [**RAlt + RCtrl + RShift + C**] to start the timer. The mode indicator window will show red and the timer will start ticking. To stop the timer, press the left crown button (1) again. The mode indicator window will show red-white (as in the figure). To reset the timer, press the left crown button once again. The mode indicator will now show white.

The stopwatch (4) is the small scale at the bottom of the clock face and is used to accurately measure short time spans (up to 1 hour). It is controlled with the right crown button (6): Press the right crown button to start the timer, press it again to stop the timer and press it once again to reset the timer.

The clock spring is wound manually by rotating the left crown button counter-clockwise to its mechanical stop. The spring contains enough energy for eight days of operation.

[Instrument panel](#)

#### **4.2.7. AGK-47B attitude indicator**

The AGK-47B combined attitude indicator features three devices in one housing with their indications output onto the front face of the housing:

- a) artificial horizon that consists of a gyroscope with three degrees of freedom with an electrical gyro motor and an electromagnetic compensator;
- b) turn indicator that consists of a gyroscope with two degrees of freedom with an electrical gyro motor and a pneumatic damper;
- c) sideslip indicator.

This attitude indicator uses the aircraft roll indication of the “view from the ground at the aircraft” type as opposed to the device installed on the F-86F aircraft that uses the indication of the “view from the aircraft at the ground” type.



- |   |                          |
|---|--------------------------|
| 1. Rotary knob to raise or lower the line of artificial horizon | 5. Moving pitch scale    |
| 2. Artificial horizon line                                      | 6. Turn indicator marker |
| 3. Aircraft symbol for roll indication                          | 7. Cage flag             |
| 4. Sideslip indicator (ball)                                    | 8. Roll scale            |
|   | 9. Cage handle           |

*(1) ROTARY KNOB TO RAISE OR LOWER THE LINE OF ARTIFICIAL HORIZON* is intended to position the line of artificial horizon conveniently in relation to the aircraft symbol when reading pitch indications (for example, when flying with displaced center of gravity or heavy weight). As a rule, the line of artificial horizon (2) is “moved” to the aircraft symbol by rotating the rotary knob (1) so that minimal pitch deflections would be immediately noticeable.

*(2) ARTIFICIAL HORIZON LINE* is a thin white line indicating the position of the horizon.

*(3) AIRCRAFT SYMBOL* indicates the aircraft position in relation to the artificial horizon.

*(4) SIDESLIP INDICATOR (BALL)* informs the pilot of the presence and value of the aircraft sideslip (when the air flow around the fuselage is not symmetrical in relation to the vertical plane): if the ball deflects to the left, it indicates flying “right side towards the flow”. If the ball deflects to the right, it

indicates flying "left side towards the flow". The more the ball is deflected from the center, the larger is the sideslip angle of the aircraft.

(5) *MOVING PITCH SCALE*. During aircraft maneuvering the scale of the device remains motionless relative to earth up to pitch angles of  $\pm 85^\circ$ . When during a vertical loop a pitch value of  $+85^\circ$  is reached, the scale ceases to rotate in relation to the aircraft. When a pitch value of  $+95^\circ$  is reached, it starts moving again, but only after a rolling turn (see device restrictions, [Table 4.1](#)). In order to obtain pitch readings, the scale is marked with the numbers "2", "4", "6", "8" and the scale graduation value is  $10^\circ$ .



(6) *TURN INDICATOR MARKER* indicates the presence of angular velocity. Deflection for one "turn bar" of the indicator corresponds to the roll of approximately  $10^\circ$  at the speed of 500 km/h. When the aircraft angular velocity reaches 4 degrees per second, the indicator ("turn bar") will reach the extreme position – if the angular velocity increases further, the indication will not change. 180,0 mm

(7) *CAGE FLAG*. When the red flag labeled АРРЕТИР (CAGE) is visible, the attitude indicator is caged.

(8) *ROLL SCALE*. Roll indications are read from the "wing" of the aircraft symbol, which moves up relative to the device. If the left "wing" of the aircraft symbol is higher than the right one relative to the artificial horizon, than it is a left roll. The scale graduation value is  $15^\circ$ . There are four marks both on the left and the right side of the instrument for  $0^\circ$ ,  $15^\circ$ ,  $30^\circ$ , and  $45^\circ$ .

(9) *CAGE HANDLE*. The cage handle is intended to actuate the mechanical caging slide, which is intended to diminish the reaction time of the gyro spin axis alignment into the vertical position. When the cage knob is pulled, an additional follow-up gimbal is set up into the zero position (exactly in the aircraft horizontal plane). АРРЕТИР ТЯНУТЬ (PULL TO CAGE) is written on the cage handle.

The AGK-47B attitude indicator is powered by the 36 V 400 Hz three-phase current from the PAG-1F transformer (belongs to the DGMK-3).

The disadvantage of the AGK-47B is disappearance of the aircraft symbol out of visible range at pitch angles of over  $\pm 40^\circ$ , which complicates roll control in such cases.

The basic data of the device are presented in Table 4.1

Table 4.1

Characteristic	Value
Ready for operation time, min	3
Pitch and roll readability in level flight mode, °	±1
Error in the device indications after banking with a roll of 15°, no more than, °	3
Error in the device indications after aerobatics, no more than, °	5
Scale range of roll, °	±95
Scale range of pitch, °	±85
Roll rate of the follow-up gimbal, °/sec	n/a
Operation temperature range, °C	-60 ... +50
Power supply	alternate three-phase current 36 V, 400 Hz, 0.6 A
Weight, kg	2.2

### [Instrument panel](#)

#### 4.2.8. Generator off warning lamp

The "Generator off" warning lamp, labeled ГЕНЕРАТОР ВЫКЛЮЧЕН (GENERATOR OFF), illuminates when there is no electromotive force at the generator terminals or a decrease in RPM below 4.000. See [actions to take in case of generator failure](#).

In spite of the fact that the warning light is on, the generator is still connected to the power network, but does not provide the required voltage. That is why many consumers are disconnected from the circuit automatically.



#### 4.2.9. VAR-75 vertical velocity indicator

The VAR-75 vertical velocity indicator measures the aircraft's rate of climb or descent. It helps the pilot to choose the best conditions for climb and descent and helps maintaining stability of flight mode. It is included in the static line of the pitot probe. The operating principle is delaying the increase/decrease of static pressure in a conditionally open aneroid box (has an orifice plate) when the flight altitude changes.



The VAR-75 shows the vertical velocity in a range of 0 to 75 m/s. On the indication, for a range of 0-15 m/s one division equals 1 m/s, for 15-75 m/s it is 5 m/s.

[Instrument panel](#)

#### 4.2.10. Gun camera status lamp

The gun camera status lamp, labeled "Ф. К. П." (F. K. P., for "Fotokamera Pulemot" or gun camera) indicates the status of the S-13 gun camera.

When the light illuminates, the gun camera is recording.

Minimum voltage for gun camera operation is 17 V.



#### 4.2.11. 300 liters warning lamp



This red 300 liters warning lamp labeled "300 ЛИТРОВ" (300 LITERS) illuminates when the remaining fuel level in the main fuel tank is 300 liters or less. The signal comes from the floating valve of the main fuel tank fuel meter. [Instrument panel](#)

#### 4.2.12. Air restart ignition off memo light

This light reminds the pilot to turn off ignition after air engine restart.



The lamp illuminates when the ignition switch on the left electrical panel is turned to the position "Запуск в воздухе" (air restart). The electrical current from the aircraft power network supplies the ignition system components and lights up the "Запуск в воздухе произвел, зажигание"

выключи” (air restart completed, turn off ignition) red lamp on the instrument panel. The starter works for 10 sec – during this time the air-fuel mixture is ignited in the engine starting fuel nozzles. Thus, as long as there is a voltage on the ignition plugs, the warning lamp remains on. If you do not turn off ignition after air restart, the ignition plugs may burn out, and it will be impossible to restart the engine again.

To turn off ignition, turn the ignition switch on the left electrical panel to ВЫКЛ (OFF).

[Instrument panel](#)

#### 4.2.13. ARK-5 SUP-7 automatic direction finder

The СУП-7 (SUP-7) is an element of the ARK-5 automatic direction finder.

When the mode selector switch is in the КОМПАС (COMPASS) position, the needle of the SUP-7 points to the radio beacon.

When the mode selector switch is in the ПАМКА (LOOP) position, the needle shows the manual deflection of the ARK-5 frame.

Minimum voltage for operation is 18.2 V.



#### 4.2.14. DGMK-3 gyromagnetic compass indicator

The ДГМК-3 (DGMK-3) gyromagnetic compass indicator indicates the heading of the aircraft (taking into account the deviation error it is equal to the



magnetic heading). It is an element of the remote gyromagnetic compass of the DGMK-3 type installed in the starboard wing.



1. Moving scale for setting desired course (rotate scale until desired heading is read on fixed mark)
2. Arrow

3. Course selector knob
4. Course selector fixed mark

One division on the scale equals  $2^\circ$ . The deviation error does not exceed  $2^\circ$ .

The moving scale (1) is rotated by the knob (3) under the vertical course selector fixed mark (4).

Pilot actions for changing heading are shown in Figure 4.6:

[Instrument panel](#)

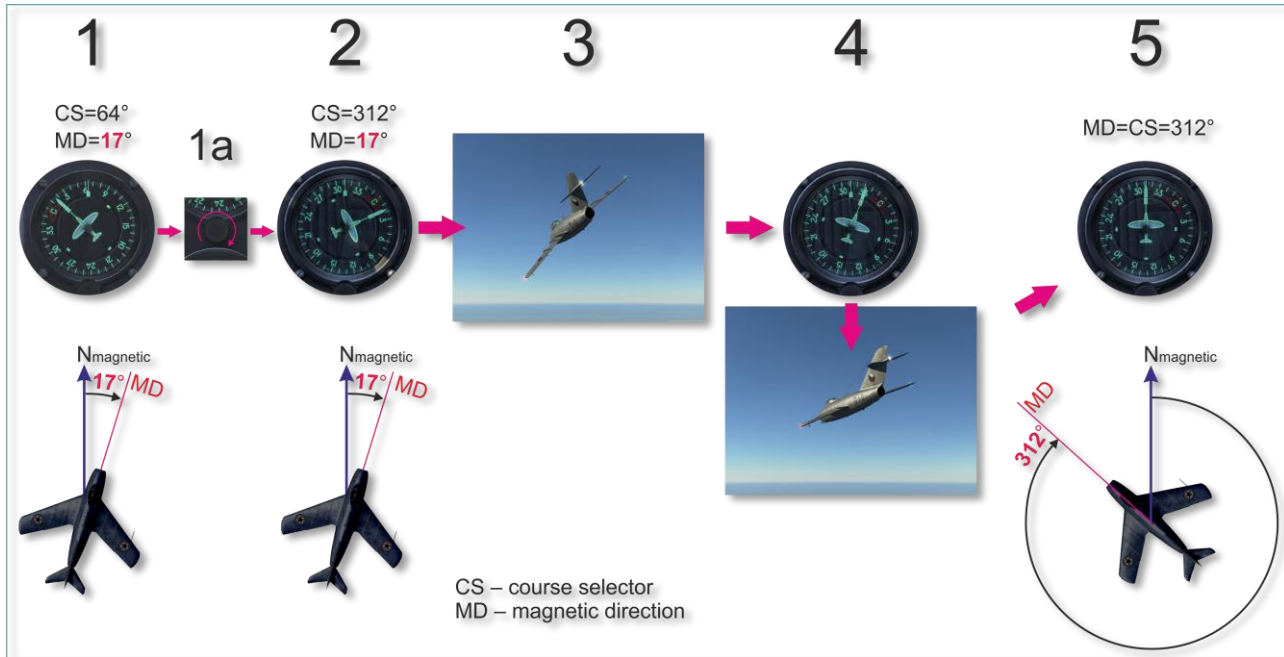


Figure 4.6. DGMK-3 usage

Point 1. Initial position. Current magnetic heading (MH) is  $17^\circ$ , fixed mark (CS) is over  $64^\circ$ .

Positions 1a-2: pilot rotates CS knob, setting new heading (in our case it is  $312^\circ$ ) and arrow with airplane symbol will follow the moving scale (i.e. MH was  $17^\circ$  and will remain the same if there were no maneuvering).

Position 3. By rolling to the left (the shortest possible way in this case) pilot performs turn to the new heading.

Position 4. Intermediate position. Being closer (MH= $332^\circ$ ) to desired heading (CS= $312^\circ$ ) pilot reduces the roll.

Position 5. Airplane is on new heading: MH=CS= $312^\circ$ .

To simplify understanding, one could imagine that during pilot turns the airplane and the aircraft-arrow on the DGMK-3 gauge.

Other main elements of the compass are magnetic sensor, gyro unit, current converter, and slave button.

The operation of the DGMK-3 is based on the ability of a floating magnet to orient itself in the plane of the magnetic meridian and on the potentiometric principle of remote transfer of the current position of the induction sensor (coil) to the gyro unit. The gyro unit filters out the vertical component of the Earth's magnetic field during aircraft maneuvering (pitch and roll variations). The position of the gyro unit is continuously aligned with that of the induction sensor. Only the horizontal component of the Earth's magnetic field is recorded, irrespective of aircraft position and attitude. The gyro unit also smoothes the alignment of the potentiometer positions of the magnetic sensor and the gyro unit, thereby preventing tremor of the compass needle during aircraft shaking.

While performing aerobatics, there can be a considerable misalignment in the positions of the induction sensor and the gyro unit ( $3...4^\circ$  for one minute of maneuvering). Shortly after maneuvering, they will align again – to speed up this process ( $17...20^\circ/\text{sec}$ ), the button labeled КОМПАС БЫСТРОЕ СОГЛАСОВАНИЕ (COMPASS – QUICK ALIGNMENT) on the instrument panel can be pressed. This button must also be used after engine start.

For piloting in emergency situations, in case of failure of the DGMK-3 or all the aircraft power supplies, the aircraft has the KI-11 magnetic compass located in the cockpit on the left of the gunsight above the instrument panel ([Figure 4.1 \(3\)](#)).

Minimum voltage for operation is 19.1 V.

[Instrument panel](#)

#### 4.2.15. TE-15 electrical tachometer



The TE-15 tachometer displays continuous indication of the rpm of the engine compressor shaft. The measurable range of rotations is 0-15000 RPM. The inner scale (0...5) is used for reading RPM values of 0 to 5000, the outer scale (6...15) for reading values of 5000 to 15000.

See the following two images for example readings:



When the indicator needle is at the position of the red mark, the readings are

- 600 or 10600 RPM (left image)
- 4000 or 14000 RPM (right image)

The sensing element of the tachometer is the generator of a three-phase alternating current, the indicator is a magnetic inductor (interchangeable). Therefore, this tachometer does not need to be connected to the aircraft electrical power system.

[Instrument panel](#)

#### 4.2.16. TGZ-47 exhaust gas temperature gauge



The TGZ-47 exhaust gas temperature (EGT) gauge measures the temperature of exhaust gas behind the turbine. The gauge is able to sense temperatures from 0 to 900°C. One division on the scale equals 20°C. The gauge is powered by the thermo-EMF (electromotive force), therefore it does not need to be connected to the aircraft electric power system.

[Instrument panel](#)

#### 4.2.17. VA-340 volt-/ammeter



The VA-340 combined volt-/ammeter measures the voltage and current in the aircraft electric power system. The upper yellow scale shows the voltage (V), the lower white scale (-40...0...120) shows the current (A). The device is normally indicating current.

The device will indicate voltage as long as the voltage display button is pressed. When the voltage display button is released, the device will indicate current again.



The label on top of the device shows all three electrical sources that can be connected to the single bus:

- ГЕНЕРАТОР – GENERATOR
- АЭРОДРОМН. – AERODROME, meaning GROUND POWER
- АККУМУЛЯТ. (АККУМУЛЯТОР) – ACCUMULATOR, meaning ONBOARD BATTERY

[Instrument panel](#)

#### 4.2.18. UVPD-3 cockpit altitude and pressure indicator



The УВПД-3 (UVPD-3) cockpit altitude and pressure indicator is an element of a pressurized cabin. It measures the “altitude” in the cockpit and the difference between the pressure inside the cockpit and the atmospheric pressure outside the aircraft.

This indicator has a dial, the upper part of which consists of a scale for the altimeter with a range of 0 to 8 km, one division being equal to 200 m; in the lower part, the dial has a pressure gauge scale with a range of 0 to 0.04 kg/cm<sup>2</sup> and 0 to +0.6 kg/cm<sup>2</sup>, one division on the vacuum scale being equal to 0.01 kg/cm<sup>2</sup>, and on the overpressure scale 0.02 kg/cm<sup>2</sup>. All the numbers, division marks, and ends of needles are covered with luminescent permanent-action paint.

When the cabin altitude exceeds 8 km and the overpressure exceeds +0.6 kg/cm<sup>2</sup>, the needles reach their stops.

[Instrument panel](#)

#### 4.2.19. EM-10 electrical remote-reading fuel pressure gauge



This gauge measures the fuel pressure, together with the [three-pointer indicator](#). In the latter, the fuel pressure gauge has a scale where one division equals  $2 \text{ kg/cm}^2$ , while on the EM-10 scale one division equals  $0.4 \text{ kg/cm}^2$ , which ensures a reliable monitoring of engine parameters when the fuel pressure is low. This is especially important for high-altitude flights where the fuel pressure drops down.

The principle of operation of the sensor is changing the position of a rheostat contactor by a membrane that bends under the fuel pressure. The modified voltage is supplied to the indicator where it changes the resulting magnetic field that deflects a permanent magnet connected to the needle. The sensor survives pressure up to  $100 \text{ kg/cm}^2$ . It is installed in the forward part of the engine on the same fuel line as the three-pointer indicator fuel pressure gauge.

[Instrument panel](#)



#### 4.2.20. Fast compass slave button



This button allows you to quickly eliminate misalignment between the magnetic sensor and the [DGMK-3](#) needle after a maneuver (the slaving rate will be 17...20°/sec).

[Instrument panel](#)

#### 4.2.21. EMI-3R three-pointer indicator



The EMI-3R is a housing for three independent indicators: the three-pointer indicator displays the fuel pressure (upper scale, 0 to 100 kg/cm<sup>2</sup>), the oil pressure (lower left scale, 0 to 10 kg/cm<sup>2</sup>), and the oil temperature (lower right scale, -50 to +150°).

As these three devices are independent, a failure of one does not affect the others. All three devices are supplied by the aircraft electrical power of 27-29 V. The division values on the scales of the indicator are 2 kg/cm<sup>2</sup> for fuel pressure, 1 kg/cm<sup>2</sup> for oil pressure and 10° for oil temperature.

When reading the fuel pressure indicator, it is important to keep in mind that this indicator is intended to measure large values of fuel pressure while the [EM-10 pressure gauge](#) measures small pressure values.

[Instrument panel](#)

#### 4.2.22. Second fuel tank empty warning lamp



The "2й бак" (second fuel tank empty) warning lamp alerts the pilot of fuel depletion in the second fuel tank. It illuminates after a pressure drop behind the PCR-1 fuel transfer pump. After that, in order to save the service life of the pump, the pump must be disengaged by the circuit breaker ([Figure 4.9, 7](#)) on the cockpit left panel.

Minimum voltage for fuel transfer pump operation is 17.3 V.

[Instrument panel](#)

#### 4.2.23. Engine start prohibited lamp



The red engine start prohibited warning light is labeled ПУСКОВОЕ ДАВ. (STARTING PRESSURE) and ЛАМПА ГОРИТ НЕ ЗАПУСКАЙ (DO NOT START ENGINE IF LIGHT IS ON).

It illuminates when the engine instruments СВ (ПРИБОРЫ КОНТРОЛЯ ДВИГАТЕЛЯ) switch is on and goes out after switching on the circuit breaker of the pump of the 2<sup>nd</sup> tank pump signal (ПОМПА 2го БАКА СИГНАЛ ПОМПЫ) when the optimal pressure from the electrical pump of the starting system is achieved (when the lamp switches off, this indicates normal operation of the electrical pump, i.e. priming fuel into the starting system).

[Instrument panel](#)

#### 4.2.24. KES-857 fuel meter



The KES-857 fuel meter is intended for remote measurement of the amount of fuel in the fuel tanks and is an element of the [aircraft fuel system](#). One division on its scale equals 100 liters. The sensor of the fuel meter sits in the first tank and has a mechanism for indicating the critical fuel level (300 liters).

[Instrument panel](#)

#### 4.2.25. M-0,95 Mach number indicator

The principle of operation of this indicator is measurement of the difference between the dynamic and the static pressure in flight with allowance for air density, using a system of aneroid boxes. A change in the positions of the membranes in the boxes ultimately changes the transfer ratio from the movable leads to the indication needle rotation axis. The device indicates the Mach number in a range of 0.3 to 0.95 Mach at flight altitudes of 0 to 12 km. One division on the scale equals 0.01 Mach. The Mach number is the relation of the true airspeed to the speed of sound for given air density.



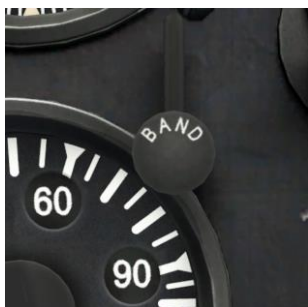
[Instrument panel](#)

#### 4.2.26. PRV-46 radar altimeter



1. PRV-46 turn-on knob
2. Indication of selected range of altitudes
3. Altitude range selector knob (BAND)

The PRV-46 is an element of the [RV-2](#) radar altimeter. It displays the aircraft's altitude above ground level in meters. It has two sub-ranges: 0-120 m and 100-1200 m. To switch between the sub-ranges, use the altitude range selector knob (3) – see Figure 4.7. The minimum voltage for PRV-46 operation is 20 V.



Indication of 0-120 m sub-range



Indication of 100-1200 m sub-range

**Figure 4.7. Indication of sub-ranges of the RV-2 by the PRV-46**

[Instrument panel](#)

#### 4.2.27. Landing gear hydraulic lever



The landing gear hydraulic lever is used to extend and retract the [landing gear](#).

#### 4.2.28. Landing gear position indication panel



It indicates the positions of the nose, main left and right landing gears. The indication in the figure corresponds to the gear in the down position. [Instrument panel](#)

#### 4.2.29. MK-12 oxygen pressure gauge



It indicates the oxygen pressure in the aircraft oxygen system. Division value is 10 kg/cm<sup>2</sup>.

[Instrument panel](#)

#### 4.2.30. V-45 landing light switch





The switch labeled  $\Phi$ APA (NOSE LIGHT) turns the landing light on and off.



[Instrument panel](#)

#### 4.2.31. IK-14 oxygen indicator



The IK-14 oxygen flow indicator (“blinker”) indicates the oxygen flow rate during breathing. It is labeled ИНДИКАТОР (INDICATOR) and КИСЛОРОДА (OXYGEN).

[Instrument panel](#)

### 4.3. Left side

The left side of the cockpit (Figure 4.8) includes the signal flare panel, gun reloading panel, radio and oxygen controls and a throttle console with its equipment.

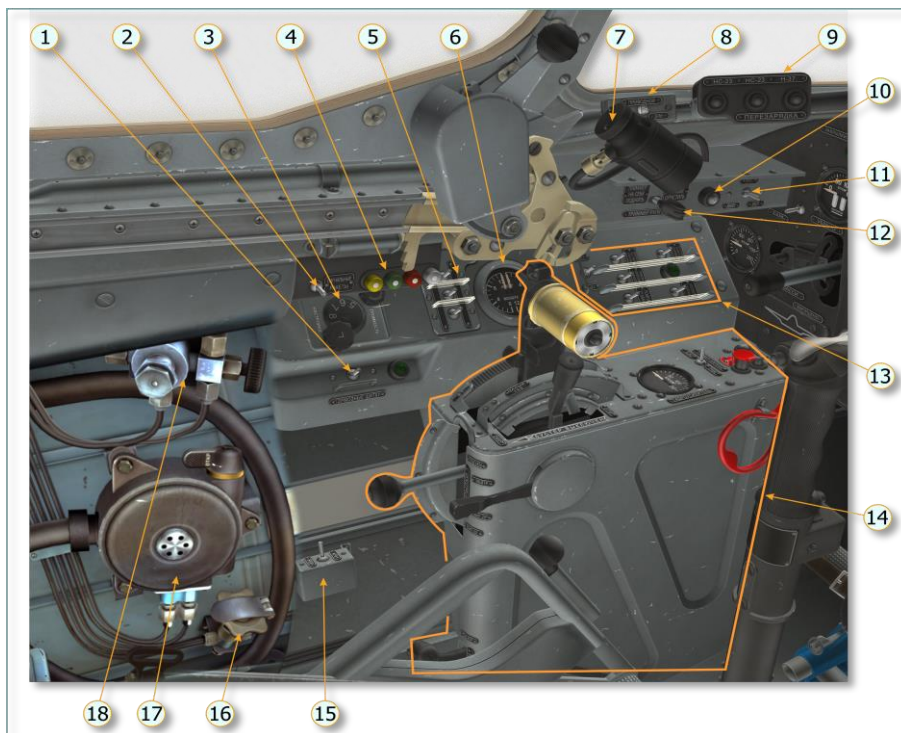


Figure 4.8. MiG-15bis cockpit left side

- |   |   |
|---|---|
| 1. <a href="#">Speedbrake extension switch</a> with extended position indication lamp | 11. <a href="#">Navigation light switch</a>   |
| 2. <a href="#">Flare switch</a>   | 12. <a href="#">Elevator trim tab control button</a>                                |
| 3. <a href="#">RSI-6 radio control panel</a>  | 13. <a href="#">Left electrical distributor panel</a>                               |
| 4. <a href="#">Flare release buttons</a>  | 14. <a href="#">Throttle console</a>  |
| 5. <a href="#">ARK-5 near-NDB select panel</a>  | 15. <a href="#">RSI-ARK telephone output switch</a>                                 |
| 6. <a href="#">Dual-pointer</a> brake pressure gauge                                  | 16. <a href="#">Oxygen supply valve</a>   |
| 7. <a href="#">Instrument panel light</a>   | 17. <a href="#">KP-14 oxygen regulator</a>  |
| 8. <a href="#">ARK-5 near-far NDB selection panel</a>                                 | 18. <a href="#">KR-14 pressure relief valve</a> with emergency oxygen supply valve. |
| 9. <a href="#">Gun reloading panel</a>  |   |
| 10. <a href="#">Elevator trim tab</a> neutral position indication lamp                |   |

(1) *SPEEDBRAKE EXTENSION SWITCH*. This switch together with the extended position indication lamp is used for extension/retraction of the speedbrakes for relatively long periods of time when it is unreasonable to hold the speedbrake extension button on the flight control stick.

The warning lamp lights up in any position of the air brakes other than the УБРАНО (RETRACTED) position. It is actuated by an end switch located on the right air brake.



(2) *SIGNAL FLARE PANEL SWITCH*. When the signal flare switch is on (up / right position), signal flare launch is enabled and flares can be launched by pressing the flare release button (4) of the corresponding color.



Minimum voltage for operation is 15 V.

(3) *RSI-6 RADIO CONTROL PANEL*. This panel accommodates the [RSI-6](#) radio controls.



(4) *FLARE RELEASE BUTTONS*. See (2).

(5) *ARK-5 RANGE SELECT PANEL* allows you to switch between the ranges of the near radio beacons (i.e. switch between those frequencies of the ARK that are available when the switch (8) is in the БЛИЖН. (NEAR) position).

(6) *DUAL-POINTER BRAKE PRESSURE GAUGE*. [This gauge](#) indicates the pressure in the main landing gear wheel brakes.

[MiG-15bis cockpit left side](#)

(7) *INSTRUMENT PANEL LIGHT*. The ARUFOSH UV light illuminates the instrument panel.

(8) *ARK-5 NEAR-FAR NDB SELECTION PANEL*. This panel contains the ПРИВОДНОЙ (HOMING) switch used for quickly switching the ARK-5 receiver to one of preset frequencies between БЛИЖИ (NEAR) and ДАЛЬИ (FAR) beacons.



(9) *GUN RELOADING PANEL*. By pressing one of the three buttons you initiate the recharge of the corresponding gun by air from the pneumatic system. When a weapon is recharged, its readiness is indicated by a corresponding illuminated red "gun ready" lamp on the [Armament control panel](#).



Minimum voltage for operation is 22 V.

(10) *ELEVATOR TRIM TAB NEUTRAL POSITION INDICATION LAMP*. This lamp illuminates when the [elevator trim tab](#) (12) is in the neutral position.

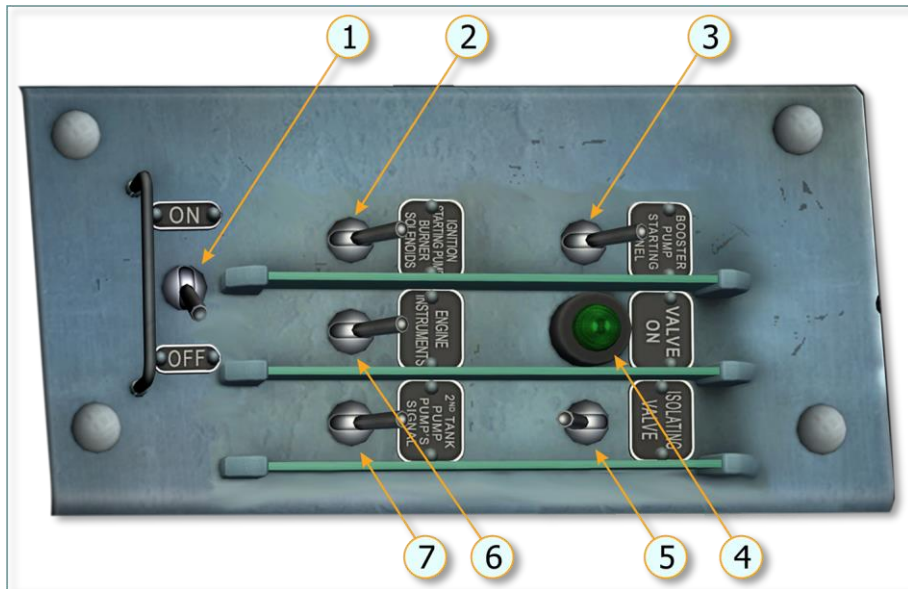


Minimum voltage for trimmers operation is 15 V. [MiG-15bis cockpit left side](#)

(11) *NAVIGATION LIGHT SWITCH* switches on/off the aircraft navigation lights.

(12) *ELEVATOR TRIM TAB CONTROL BUTTON*.

(13) *LEFT ELECTRICAL DISTRIBUTION PANEL*. This panel allows you to switch on equipment for engine, fuel system, hydraulic actuators. The green lamp (4) illuminates when the isolating valve of the engine fuel automatics is activated.



**Figure 4.9. Left electrical distribution panel**

- |  |   |
|--|---|
| 1. Engine air restart switch   | 5. Isolation valve switch - ИЗОЛИР. КЛАПАН                                  |
| 2. Engine ignition, primer pump, magnetic plug of fuel nozzle switch - ЗАЖИГАНИЕ: ПУС. ПОМПА, СОЛЕНОИДЫ ФОРСУНОК | 6. Engine instruments switch - ПРИБОРЫ КОНТРОЛЯ ДВИГАТЕЛЯ                   |
| 3. Booster pump switch - БУСТЕР ПОМПА  | 7. Indication of second pump operation switch - ПОМПА 2ro БАКА СИГНАЛ ПОМПЫ |
| 4. Isolation valve activation indication lamp  |   |

(14) *THROTTLE CONSOLE* is a cockpit object that accommodates controls of systems and equipment, see [Figure 4.10](#).

(15) *RSI-ARK TELEPHONE OUTPUT SWITCH*



Allows you to switch the headphones into the mode of listening to the ground beacon (APK) callsigns **together with** the RSI-6 receiver or **only** the RSI-6 radio receiver (ПРИЕМ).

[MiG-15bis cockpit left side](#)

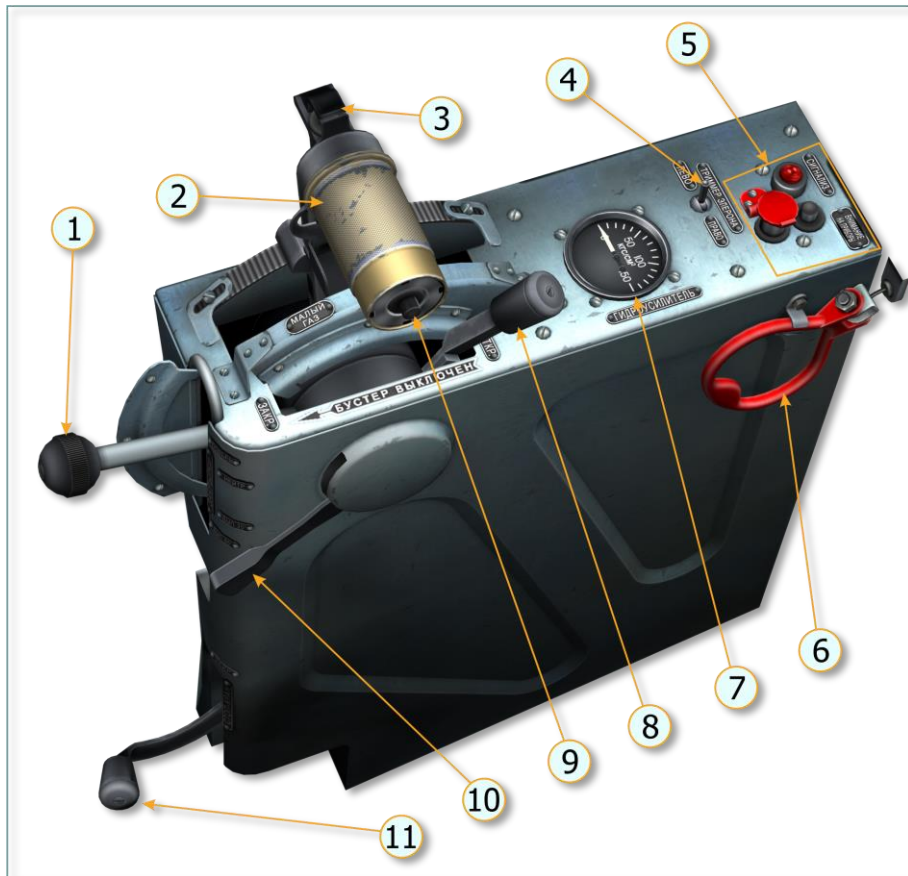
(16) *OXYGEN SUPPLY VALVE*. The onboard oxygen supply valve is part of the oxygen supply system, designed to open oxygen flow from cylinders to the KR-14 pressure relief valve.

(17) *KP-14 OXYGEN REGULATOR*. It is part of the oxygen supply system, designed for cockpit air and pure oxygen mixing according in specific ratio (depending on flight altitude) and feeding the resulting mixture into the pilot's oxygen mask.

(18) *KR-14 PRESSURE RELIEF VALVE WITH EMERGENCY SUPPLY VALVE*. It is part of the oxygen supply system, designed for reducing oxygen pressure before it gets into KP-14. [MiG-15bis cockpit left side](#)

### ***Throttle console***

The throttle console accommodates the engine control, speedbrake control, hydraulic actuator control, fire protection control, aileron trim tab and other controls.



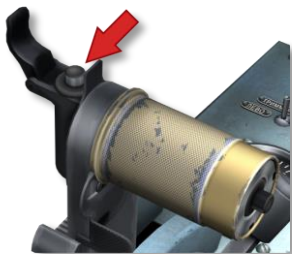
**Figure 4.10. Throttle console**

- |  |   |
|--|---|
| <ol style="list-style-type: none"> <li>1. Flaps control handle</li> <li>2. <a href="#">Engine throttle</a> with rotary handle for gunsight range control</li> <li>3. <a href="#">Engine starter button</a> with safety cover</li> <li>4. <a href="#">Aileron trim tab switch</a></li> <li>5. <a href="#">Fire extinguishing system control</a> unit</li> </ol> | <ol style="list-style-type: none"> <li>6. <a href="#">Left main landing gear lock manual</a> (emergency) unlock handle</li> <li>7. <a href="#">Hydraulic actuator pressure gauge</a></li> <li>8. <a href="#">Hydraulic actuator control handle</a></li> <li>9. <a href="#">RSI-6K radio transmission switch</a></li> <li>10. <a href="#">Engine throttle friction adjustment</a> lever (not simulated)</li> <li>11. <a href="#">Engine shut-off valve</a>.</li> </ol> |
|--|---|

(1) *FLAPS CONTROL HANDLE*. This handle is used to extend (to 20° or 55°) and retract flaps. See [flaps](#).

(2) [Engine throttle](#) WITH TWIST GRIP FOR GUNSIGHT RANGE CONTROL. Backward and forward movements of the throttle change the engine operating mode. Rotation of the handle, through a system of actuators, allows you to set the gunsight range.

(3) *ENGINE STARTER BUTTON* with a safety cover.



(4) *AILERON TRIM TAB SWITCH*. This switch allows you to control the position of the trim tab on the [aileron surface](#).

(5) *FIRE EXTINGUISHING CONTROL PANEL*. This panel detects and indicates engine fire and controls the supply of fire suppressant, see [5.9](#).



(6) *LEFT MAIN LANDING GEAR LOCK MANUAL (EMERGENCY) UNLOCK HANDLE* mechanically releases the unlocks of the left main landing gear.

(7) *HYDRAULIC ACTUATOR PRESSURE GAUGE*. This gauge labeled ГИДРОУСИЛИТЕЛЬ (HYDRO BOOSTER) displays the pressure in the hydraulic system of the hydraulic actuator. [Throttle console](#)





(8) *HYDRAULIC ACTUATOR CONTROL HANDLE*. Pulling this handle back disengages the hydraulic actuator. From this moment, the pilot feels the aerodynamic forces from the ailerons in the roll channel. The implementation of the occurring forces is dependent on the IAS: At first, slowness of the control stick rolling motion is noticed. Then, starting at a certain speed, when the maximal force is achieved, a stroke limitation of the control stick occurs.



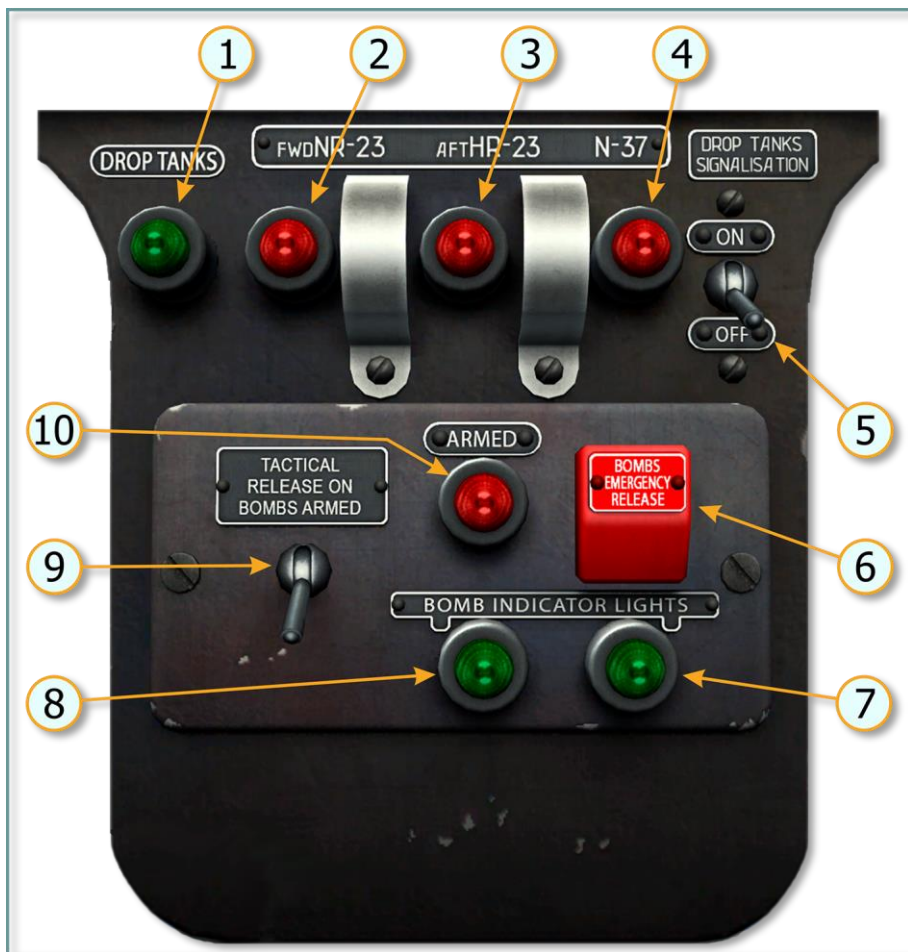
(9) *RSI-6K RADIO TRANSMISSION SWITCH*. As long as this switch is held down `|RAIt + \`, the RSI-6K works as a transmitter.

(10) *ENGINE THROTTLE FRICTION ADJUSTMENT LEVER*. This lever allows you to adjust the force required to move the throttle. Not simulated.

(11) *ENGINE SHUT-OFF VALVE*. This valve belongs to the [engine controls](#) and serves to switch the high pressure fuel line for return and simultaneously cut off the fuel from the engine nozzles. [Throttle console](#)

#### **4.4. Armament control panel**

The armament control panel, located under the instrument panel, is used to control armament and indicate its condition. The armament control panel is an element of the aircraft armament system.



**Figure 4.11. MiG-15bis armament control panel**

- |  |   |
|--|---|
| 1. Empty drop tank indication light  | 7. <a href="#">Load presence lamp</a> (right pylon) |
| 2-4. <a href="#">Gun ready lights</a>  | 8. Load presence lamp (left pylon)                  |
| 5. <a href="#">Empty drop tank indication switch</a><br>(turns on/off signalization) | 9. <a href="#">Bombs arming circuit switch</a>      |
| 6. <a href="#">Emergency release button</a>  | 10. <a href="#">Bombs armed lamp</a>                |

(1) *EMPTY DROP TANK INDICATION LIGHT*. This green light labeled ПОДВ. БАКИ (EXTERNAL DROP TANKS) illuminates when fuel from external tanks runs out or when the engine RPM is lower than 6000 (due to the low

pressurization in the tanks). The light goes out when the empty drop tank indication switch (5) is off.

(2), (3), (4) *GUN READY LIGHTS*. The three red gun ready lights indicate shooting readiness of the three guns and illuminate when [reloading](#) (ramming of a round into a barrel from a belt) is accomplished – [see also](#).

They indicate – from left to right – gun readiness of the ...

- front NR-23 (ПЕР HP-23) gun (2)
- rear NR-23 (ЗАДН HP-23) gun (3)
- N-37D (H-37) gun (4)

The minimal voltage for gun reloading is 22 V.

(5) *EMPTY DROP TANK INDICATION SWITCH*. This signalization switch labeled СИГНАЛИЗ. ПОДВ. БАКОВ (DROP TANKS ALARM TRIGGERING) has two positions:

- Up: ВКЛ (ON)
- Down: ВЫКЛ (OFF)

If the switch is in the on position, the empty drop tank indication light (1) is enabled. In the off position, the indication light stays off.

(6) *EMERGENCY RELEASE BUTTON*. This guarded button labeled АВАР. СБРОС БОМБ (EMERGENCY BOMB RELEASE) is used for the emergency release of bombs and external tanks. After the protective cap is opened and the switch is pushed, an emergency circuit releases the bombs (or drop tanks).

(7), (8) *LOAD PRESENCE LAMPS*. These green lamps labeled ЛАМПЫ ПОДВЕСКИ БОМБ (BOMB SUSPENSION LIGHTS) illuminate when load (either bombs or drop tanks) is present on the right (7) and the left (8) pylon respectively. When a bomb or drop tank is released from a hardpoint, the corresponding light goes off.

(9) *BOMBS ARMING CIRCUIT SWITCH*. This switch labeled ТАКТИЧЕСКИЙ СБРОС ВКЛЮЧЕН НА ВЗРЫВ (TACTICAL RESET ON BLAST) has two positions:

- Up: ON, bomb fuse activated (armed). Bombs will be released in the ВЗРЫВ (EXPLOSION) setting and detonate on impact.
- Down: OFF, bomb fuse deactivated (disarmed). Bombs will be released at the НЕВЗРЫВ (NO EXPLOSION) setting and will not detonate on impact. [Armament control panel](#)

In the up position, bombs will be armed for both tactical (normal) and emergency bomb release. In the down position, bombs will be disarmed for both cases.

(10) *BOMBS ARMED LAMP*. This red lamp labeled B3PЫB (DETONATION) will illuminate when the bombs are armed (fuse is activated) and will detonate on impact, i.e. when the bombs arming circuit switch (9) is in the on position.

The minimal voltage for the lamp is 18 V.

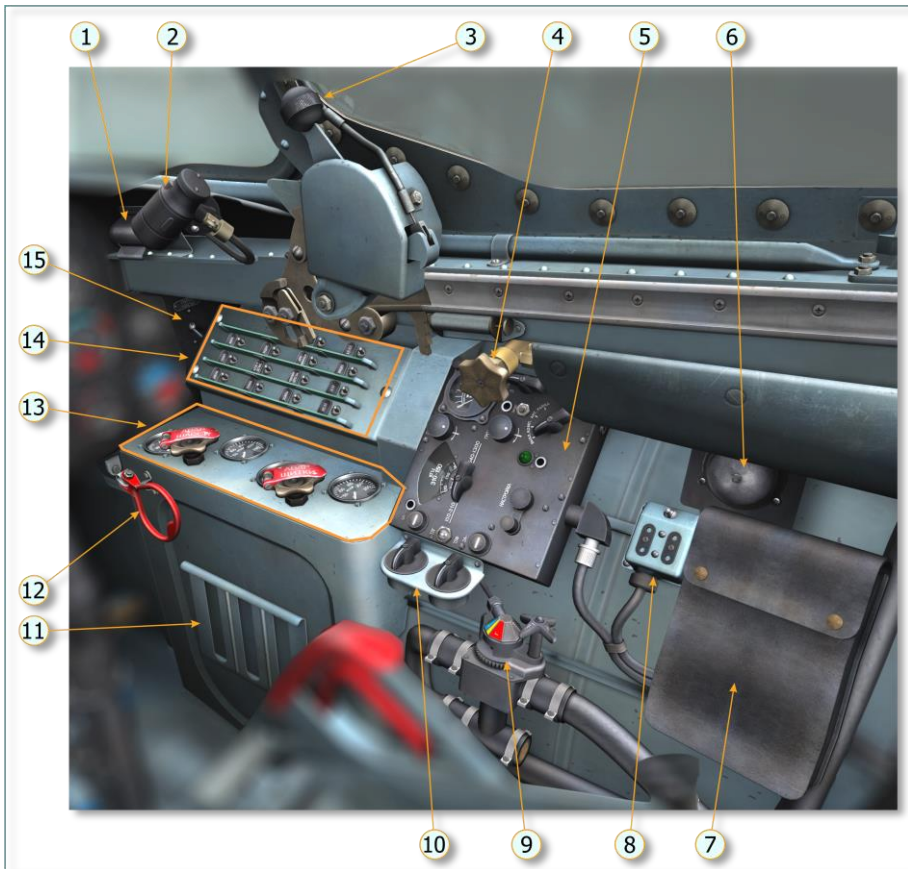
[See also. Armament control panel](#)

#### **4.5. ASP-3N gunsight**

The automatic gyro ASP-3N gunsight is used to assist aiming during shooting. The device is described in [5.8.3](#).

#### **4.6. Right side**

The right side of the cockpit (Figure 4.12) includes lamps, radio controls and several electrical switches.

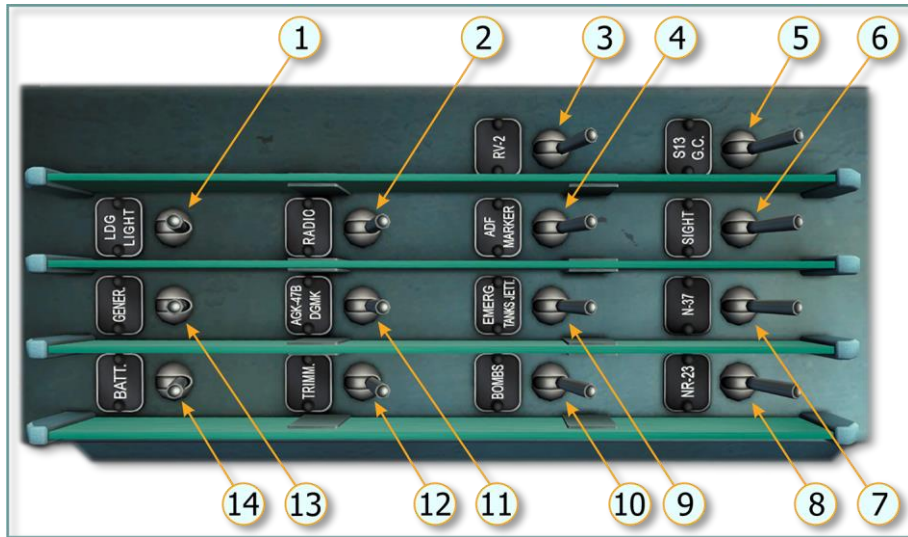


**Figure 4.12. MiG-15bis cockpit right side**

- |  |   |
|--|---|
| 1. <a href="#">KLS-39</a> cockpit lamp                                 | 10. <a href="#">RUFO-45</a> UV lamp rheostats                         |
| 2. <a href="#">ARUFOSH</a> UV lamp                                     | 11. <a href="#">Map holder</a>  |
| 3. <a href="#">Canopy handle</a>                                       | 12. <a href="#">Nose and right landing gear emergency lock handle</a> |
| 4. <a href="#">Emergency air tanks recharge valve</a>                  | 13. <a href="#">Right side horizontal panel</a>                       |
| 5. <a href="#">ARK-5</a> control panel (K-7)                           | 14. <a href="#">Right electrical distribution panel</a>               |
| 6. <a href="#">MRP-48P</a> system buzzer                               | 15. <a href="#">Pitot and clock heater switch</a>                     |
| 7. <a href="#">Oxygen mask bag</a>                                     |   |
| 8. <a href="#">Micro telephone panel</a>                               |   |
| 9. <a href="#">Cockpit and canopy pressurization hose supply valve</a> |   |

- (1) *KLS-39 COCKPIT LAMP*. This lamp is intended for illumination of the right electrical distribution panel (14) and the right side horizontal panel (13).
- (2) *ARUFOSH UV LAMP*. This lamp is used to illuminate the instrument panel. Gauge arrows are covered by a special paint, which illuminates when exposed to UV rays.
- (3) *CANOPY HANDLE*. This handle is used for opening or closing the canopy. This can be done using only one handle – either the left or the right one.
- (4) *EMERGENCY AIR TANKS RECHARGE VALVE*. This valve is used for recharging the emergency air tanks during ground maintenance (ground pneumatic maintenance is not simulated).
- (5) *ARK-5 CONTROL PANEL*. This panel is used to control the [ARK-5](#) Automatic Direction Finder (ADF).
- (6) *MRP-48P SYSTEM BUZZER*. This buzzer is used for acoustic signaling of marker beacon overflight. The signal to the buzzer is provided by the [MRP-48P](#) equipment. The corresponding indicator light on the instrument panel illuminates together with the buzzer sound.
- (7) *OXYGEN MASK BAG*. This bag is designed for storing the pilot's oxygen mask (mask extraction and packing are not animated).
- (8) *MICRO TELEPHONE PANEL*. This panel is used to connect the pilot's helmet headset to the wired aircraft radio equipment.
- (9) *COCKPIT AND CANOPY PRESSURIZATION HOSE SUPPLY VALVE*. The supply valve is connected with two aircraft systems and consists of two parts: plug valve which is used for the cockpit air supply control (from air supply and cockpit ventilation system/environmental control system), and slide valve which opens air supply to the canopy pressurization hose (from air system).
- (10) *RUFO-45 UV LAMP RHEOSTATS*. These rheostats are used for changing the light intensity of the ARUFOSH UV lamps.
- (11) *MAP HOLDER*. Cannot be used in the simulation.
- (12) *NOSE AND RIGHT LANDING GEAR EMERGENCY LOCK HANDLE*. This handle mechanically opens the nose and right landing gear locks in case of emergency release.
- (13) *RIGHT SIDE HORIZONTAL PANEL*. This panel ([Figure 4.14](#)) includes pressure gauges and emergency extension valves. [Cockpit right side](#)

(14) **RIGHT ELECTRICAL DISTRIBUTION PANEL.** This panel (Figure 4.13) is used to turn the following items on and off: lights, electrical units, radio electronic equipment, trimmers, gyrocompass, attitude indicator and armament system objects.



**Figure 4.13. Right electrical distribution panel**

- |   |  |
|---|--|
| 1. ФАРА (Landing light)   | 9. АВАРИЙН.СБРОС БАК.<br>(Emergency tanks release circuit) |
| 2. РАДИО (RSI-6K radio)   | 10. БОМБЫ (BOMBS)  |
| 3. РВ-2 (RV-2 radio altimeter)                                  | 11. АГК-47Б ДГМК<br>(AGK-47B DGMK artificial horizon)      |
| 4. АРК МАРКЕР (ARK direction finder and marker beacon receiver) | 12. ТРИММ. (Trimmers electric motors)                      |
| 5. Ф.П.-С13 (S-13 gun camera)                                   | 13. ГЕНЕР. (DC generator)                                  |
| 6. ПРИЦЕЛ (АСП-3Н) (ASP-3N gunsight)                            | 14. АККУМ. (Battery)                                       |
| 7. Н-37 (37 mm N-37 automatic cannon)                           |  |
| 8. НР-23 (23 mm NR-23 automatic cannons)                        |  |

(15) **PITOT AND CLOCK HEATER SWITCH.** This switch is used for heating the ПИТО (PITOT TUBE) and ЧАСЫ (CLOCK). [Cockpit right side](#)

#### **Right side horizontal panel**

([Figure 4.12](#), 13)



**Figure 4.14. Right side horizontal panel**

- |   |  |
|---|--|
| <ol style="list-style-type: none"> <li>1. Emergency landing gear pneumatic pressure gauge</li> <li>2. Emergency landing gear extension valve</li> <li>3. Utility hydraulic system pressure gauge</li> </ol> | <ol style="list-style-type: none"> <li>4. Emergency flaps pneumatic pressure gauge</li> <li>5. Emergency flaps extension valve</li> <li>6. Main pneumatic system pressure gauge</li> </ol> |
|---|--|

(1) *EMERGENCY LANDING GEAR PNEUMATIC PRESSURE GAUGE.* This gauge labeled ВОЗДУХ (AIR) indicates the pressure in the emergency landing gear extension air tanks (main landing gear) up to 80 kg/cm<sup>2</sup>.

Cavities in the main landing gear are used for storage of compressed air for emergency extension of the landing gear.

(2) *EMERGENCY LANDING GEAR EXTENSION VALVE.* This valve is used for [emergency extension of the landing gear](#).

(3) *UTILITY HYDRAULIC SYSTEM PRESSURE GAUGE.* This gauge labeled ГИДРАВЛИКА (HYDRAULICS) indicates pressure in the [utility hydraulic system](#) (Figure 5.4) up to 250 kg/cm<sup>2</sup>.

(4) *EMERGENCY FLAPS PNEUMATIC PRESSURE GAUGE.* This gauge labeled ВОЗДУХ (AIR) indicates the pressure in the emergency flaps extension air tank up to 80 kg/cm<sup>2</sup>. It is needed for emergency tank refueling control.

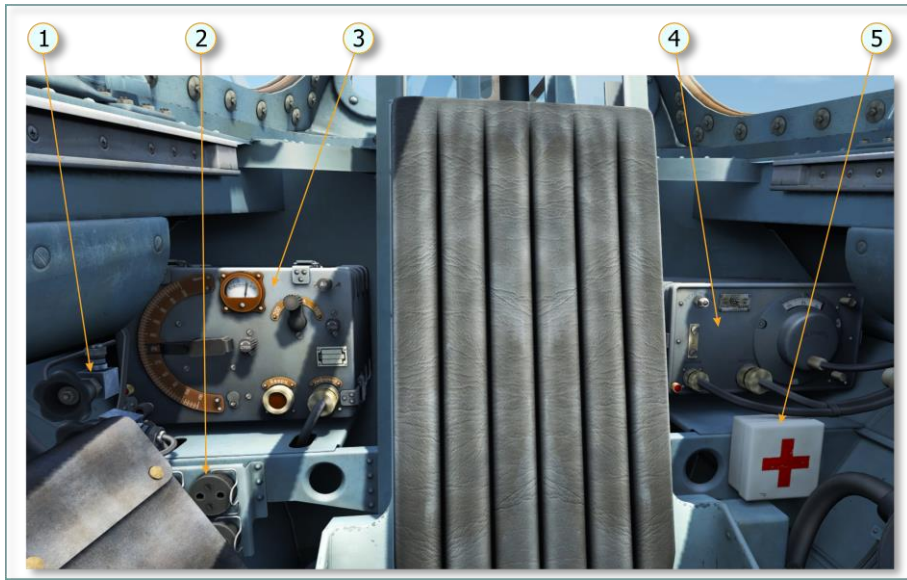
(5) *EMERGENCY FLAPS EXTENSION VALVE.* This valve is used for the [emergency extension of flaps](#) (55° position only).



(6) *MAIN PNEUMATIC SYSTEM PRESSURE GAUGE*. This gauge labeled ВОЗДУХ (AIR) indicates pressure in the pneumatic / air system ([Figure 5.9](#)) up to 250 kg/cm<sup>2</sup>.

#### 4.7. Back side of the cockpit

The back side of the cockpit ([Figure 4.15](#)) includes the following equipment which is installed on the left and right sides, behind the pilot's seat: valves, sockets, radio controls and a first aid kit.



**Figure 4.15. MiG-15bis cockpit back side**

- |  |                                       |
|--|---------------------------------------|
| 1. Air network valve ( <a href="#">Figure 5.9</a> , 6) and cockpit air supply valve ( <a href="#">Figure 5.9</a> , 7) (air system) | 3. RSI-6 radio set RSI-6K transmitter |
| 2. Portable lamps sockets  | 4. RSI-6 radio set RSI-6M1 receiver   |
|  | 5. First aid kit                      |

(1) *AIR NETWORK VALVE AND COCKPIT AIR SUPPLY VALVE*. Both valves belong to the [pneumatic system](#).

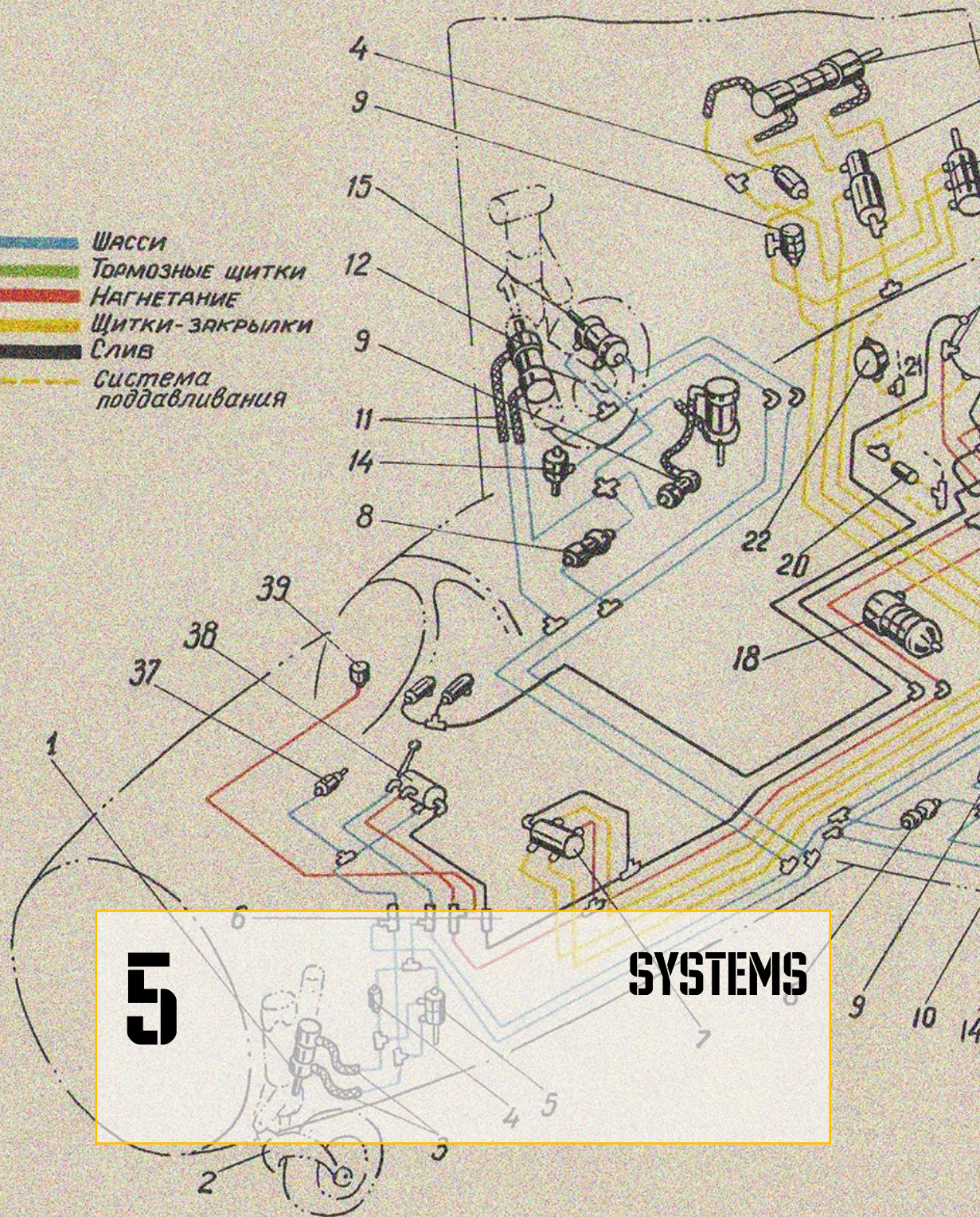
(2) *PORTABLE LAMPS SOCKETS* are not modeled.

(3) *RSI-6K TRANSMITTER*. This unit is part of the RSI-6 radio set and used for antenna control and frequency tuning of the transmitter – see [RSI-6K transmitter](#).

(4) *RSI-6M1 RECEIVER*. This unit is part of the RSI-6 radio set. It can be controlled with the [receiver control panel](#), located on the left side of the cockpit.

(5) *FIRST AID KIT*. The first aid kit is not simulated.

- ШАССИ
- ТОРМОЗНЫЕ ЩИТКИ
- НАГРЕТАНИЕ
- ЩИТКИ-ЗАКРЫЛКИ
- СЛИВ
- Система поддавливания



Фиг. 78. Гидросистема самолета

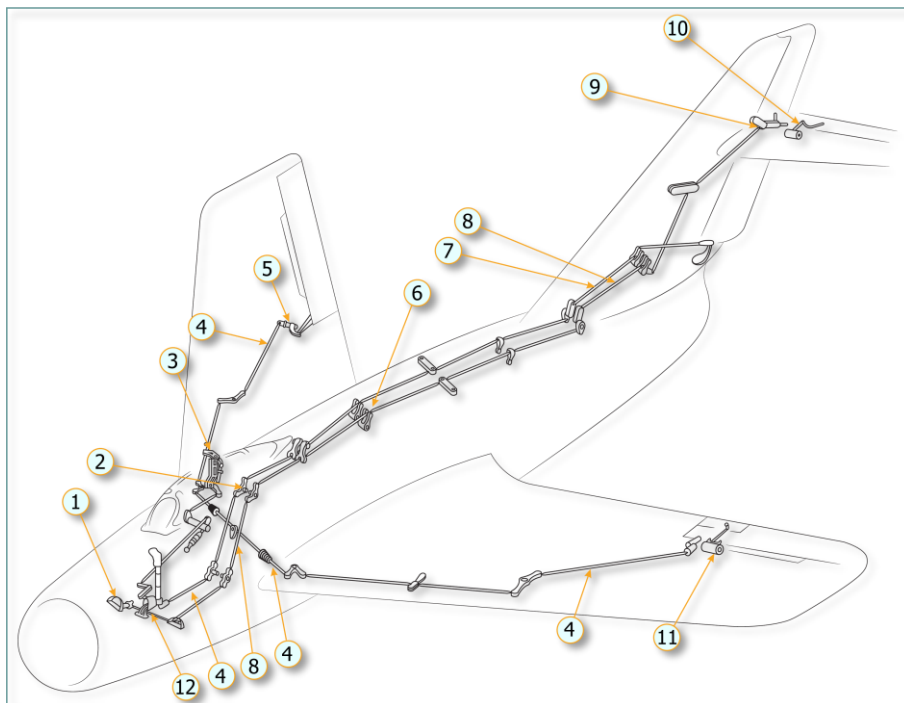
1—гидрозамок; 2—носовая стойка; 3—шланги подключения гидрозамка; 4—обратный клапан; 5—цилиндр замка подвески носовой стойки; 6—резервуар в полу кабины; 7—кран

21—обратный клапан; 22—тортальный клапан

## 5. SYSTEMS

### 5.1. Flight control system

The flight control system (Figure 5.1) includes [cockpit controls](#), control surfaces and the systems for transferring the pilot's inputs to the control surfaces.



**Figure 5.1. Flight control system**

- |   |                               |
|---|-------------------------------|
| 1. Pedal (right)                                | 7. Rudder control line        |
| 2. Control lines leading out of the cockpit     | 8. Elevator actuator          |
| 3. Hydraulic booster                            | 9. Elevator actuator          |
| 4. Aileron control line                         | 10. Elevator trimmer actuator |
| 5. Aileron control joint<br>(actuator and yoke) | 11. Aileron trimmer actuator  |
| 6. Control link joint column                    | 12. Flight control node       |

The flight control system is mechanical, consisting of rods and cranks. It means that, in case of complete loss of power, the flight control system will still be available. The cockpit controls are described in section [4.1](#). The operation of the control surfaces in connection with the cockpit controls and the systems that transfer the pilot's inputs are described below.

### 5.1.1. Elevator in the flight control system (pitch control)

Elevator design is described [here](#).

Elevator cockpit controls are described [here](#).

*ELEVATOR CONTROL FROM THE COCKPIT* is achieved by moving the control stick forward and backward. When the elevator is in the neutral position, the control stick is deflected backward by  $6^{\circ}30'$  from the vertical (this corresponds to the neutral position of the joystick). The maximum angle of the elevator vertical deflection is  $32^{\circ}$  upward and  $16^{\circ}$  downward. To deflect the elevator upward by  $32^{\circ}$ , pull the control stick by  $26^{\circ}$  from the neutral position. To deflect the elevator downward, push the control stick forward by  $14^{\circ}$ .

Therefore, the elevator control logic is non-linear for the deflection of the control surface, but it is linear for the deflection of the cockpit control stick. For a gamer it feels as follows: when pulling the control stick backward, the positive g-load will be much stronger (the transfer factor is 1.64) than for the same deflection of the control stick forward (the transfer factor is 1.14).

In order to simulate forces on the control stick which depend on aerodynamic forces applied to control surfaces (ailerons, elevators and rudder), an artificial non-linear transfer function is introduced. At certain modes you can notice a difference between the deflection of the joystick and that of the control stick in the cockpit. For example, at high speed when the joystick is pulled fast all the way back, at first the control stick will move fast then slower and at the end will stop in an intermediate position. This indicates that the maximal possible force typical for a pilot of the late 50s applied to the control stick is not enough to fully deflect the control surfaces.

*ELEVATOR TRIMMER CONTROL* is fly-by-wire, achieved by an electric motor installed on the spar of the horizontal stabilizer.

The translational movement of the electric motor gearbox rod is transferred through a lever to the rod that runs through the hole in the wall of the rear stringer of the horizontal stabilizer and ends in the elevator with a drive shaft and a rod connected to the trimmer. The axis of the drive shaft in the trimmer's neutral position coincides with the elevator rotation axis. The electric motor is supplied by the aircraft power supply through a thermal fuse.

The electric motor is controlled by a [pushbutton](#) on the left vertical panel that can be pushed forward |RCtrl + ;| to descend or pulled backward |RCtrl + .| to climb.



The elevator trimmer can deflect from the neutral position up and down by  $10^{\circ} \pm 1$ . The neutral position of the trimmer is indicated in the cockpit by the neutral position lamp located on the left vertical panel.



For trimmer control, it is recommended to make quick pulls/pushes of the switch – this will allow a more precise setting of the trimmed surface and therefore ensure the required pitch angle of the aircraft.

### 5.1.2. Ailerons in the flight control system (roll control)

Aileron design is described [here](#).

Aileron cockpit controls are described [here](#).

*AILERON CONTROL FROM THE COCKPIT* is achieved by moving the control stick left or right. The maximum angle of the left and right deflection of the control stick is  $20^{\circ}$ . This deflection corresponds to an aileron deflection of  $15^{\circ}$ . Aileron control is identical for the left and right aileron. To facilitate mechanical aileron control, the control system has a hydraulic booster of the type BU-1, which is installed in the right wing and has its own [booster hydraulic system](#).

From the flight control node, the aileron control line runs along the right side of the cockpit to the intermediate column. The column has a hermetical output. At the end of this output in the right wing there is a crank. From the crank, the rod goes to the lever connected with the hydraulic booster (3). The rods go into the left wing through the hermetical outputs on the fuselage. The other end of the rod of the hydraulic booster is connected with a two-arm lever through intermediate lugs. From the two-arm lever the motion is transferred to two rods (4): to the left and right ailerons and then through the unit with bearings and pipes with two levers - to the aileron control joint (5).

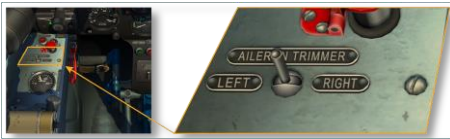
As the hydraulic booster completely eliminates the response of aerodynamic loads on the stick, there is an artificial feel mechanism to enhance the feel of roll control at low speeds: a cylinder with a spring.

In the event of hydraulic booster failure, the hinge moment from the ailerons is transmitted to the control stick, while the hydraulic booster continues to operate in the aileron control system as a rigid element. The roll control in this case is still available, but for the player it feels as if maximum deflection of the control stick for roll control is reduced (imitation of the necessity to apply greater force to the control stick).

*AILERON TRIMMER CONTROL*, as well as elevator trim control, is fly-by-wire, achieved by the electric motor installed on the rear stringer of the left wing.

Translational motion is transmitted from the motor gearbox rod through the drive shaft and an intermediate crank to the rod connected with the aileron trim tab.

The electric motor is controlled by a pushbutton on the throttle console that can be pushed left |[RCtrl + ,](#)| or right |[RCtrl + /](#)|.



This mechanism ensures the deflection of the trim tab by  $\pm 15^\circ$ .

When trimming, it is recommended to do short pushes of the pushbutton to the left or right. This allows a more precise control of the trim tab and ensures the required trimming of the aircraft roll. There is no signal that indicates the neutral position of the aileron trim tab.

### 5.1.3. Rudder in the control system (directional or yaw control)

Rudder design is described [here](#).

Rudder cockpit controls are described [here](#).

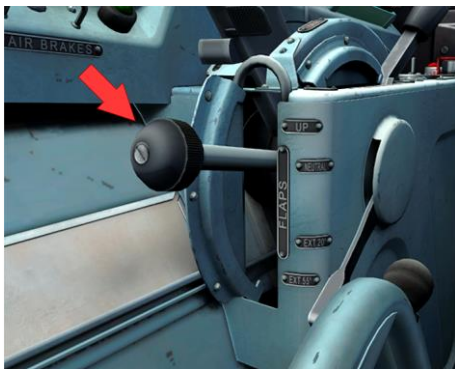
*RUDDER CONTROL FROM THE COCKPIT* is achieved by pedal inputs. The pedals limit deflection angle to the left and to the right is  $29^\circ$  from the neutral position. When a pedal is completely deflected, the rudder is deflected to the left or right by  $20^\circ$ . Forces on the pedals in the yaw channel are simulated in a similar way to those of the pitch channel.

The rudder control rods are connected to the levers of the control surfaces through a system of units and cranks. On the rudder lever, additional weight is installed. The rudder actuator is a one-sided lever. At the bottom, the rudder has a balance weight.

### 5.1.4. Flaps control

The design of the flaps is described [here](#).

*FLAPS CONTROL FROM THE COCKPIT* is achieved by the four-position flap extension / retraction control stick (lever) on the throttle console on the [left side](#) of the cockpit:



**Figure 5.2. Flap extension/retraction control stick (lever)**

The flaps control stick is connected by rods with a special hydraulic lever that controls two hydraulic actuators installed in the wings and included into the [utility hydraulic system](#).

As there is a rigid mechanical connection between the stick and the lever, the flap extension/retraction control stick located on the throttle console will be referred to as *FLAPS EXTENSION LEVER*.

When the lever is moved for extension, the hydraulic fluid first flows into the actuators of the locks and then into the hydraulic actuators of the flaps. In the open position, the flaps are locked with a hydraulic lock, but only in the ВЫП. 55° (EXTEND 55°) position. For the description of the hydraulic system see [5.4](#).

The design of the control system in the left and right wing is identical. The parts of the control system of the left and right wing are connected by a double cable that allows synchronization of both hydraulic actuators.

The hydraulic valve handle has four fixed settings – from top to bottom:

- ПОДЪЕМ: UP



- НЕЙТР (Нейтрально): NEUTRAL
- ВЫП. (ВЫПУСТИТЬ) 20°: EXT 20°
- ВЫП. (ВЫПУСТИТЬ) 55°: EXT 55°.

### ***Specific features of flap extension process***

**20° FLAP EXTENSION.** In order to extend the flaps to 20° (takeoff angle), you should set the hydraulic valve to the ВыП. 20° position. When the flaps are extended to 20°, they are held by pressure in the hydraulic system only, because the hydraulic lock is not activated. For this reason, if the hydraulic valve handle is set to the НЕЙТР (NEUTRAL) position from the ВыП. 20° position, the hydraulic lock will not be activated (the needed cavity of the hydraulic lock will not be filled with hydraulic fluid), in all the retraction/extension cavities of hydraulic cylinders the fluid pressure will be the same and, thus, gradually the flaps under the action of aerodynamic forces will be hold a position close to the neutral one.

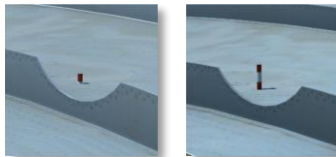
**55° FLAP EXTENSION.** In order to extend the flaps to 55° (landing angle), you should first extend the flaps to 20°, wait at least 2 seconds and only after that set the hydraulic valve in the ВыП. 55° position.

**Important:** In order to fully open the locks of the flaps, you should hold the extension hydraulic valve in the ВыП. 20° position for at least 1.5-2 sec.

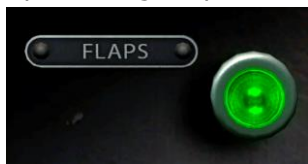
After the flaps are extended to 55°, you should set the hydraulic valve handle in the НЕЙТР (NEUTRAL) position, because in the 55° position the flaps are held by the hydraulic lock and there is no need to continue pressurizing the mixture into the extension cavities of the hydraulic cylinders. The retract ПОДЪЕМ (RAISE) position is intended for forced fluid drain from the cavities of hydraulic locks thereby opening and also for pressurizing the fluid into the “retraction” cavity of hydraulic cylinders.

Flaps extension is controlled by:

- Mechanical indicator on the left wing (left: 20° position, right: 55° position):



- Flaps warning lamp on the instrument panel:



### 5.1.5. Speedbrake control

The design of the speedbrakes is described [here](#).

The speedbrakes are controlled by a two-position (on-off) electromagnetic lever powered by the utility hydraulic system.

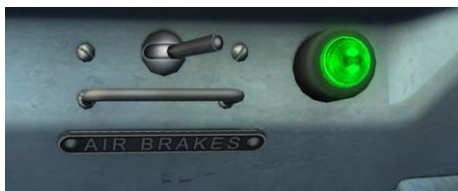
When extended, the speedbrakes are held in the extended position by the hydraulic fluid pressure.

*CONTROL FROM COCKPIT.* For a short-term air brake extension you should switch on the electromagnet of the air brake valves by pressing and holding down a button on the control stick:



Note that the air brakes will inadvertently start retracting right after the button is released because of the air flow they are exposed to.

If you need to extend the air brakes for a longer time period (for example, during diving), set the switch labeled **ТОРМОЗНЫЕ ЦИТКИ (AIR BRAKE)** on the left console to the **ВЫПУСК (EXTEND)** position:



The **ВЫПУСК** switch on the left panel and signal lamp, indicating that air brakes are extended at 55°.

The air brake opening angle is  $55^{\circ} \pm 1^{\circ}$ . Start of the air brake opening is controlled by a warning lamp in the cockpit, which is actuated by the end switch located on the right air brake.

The minimal system voltage for air brake operation is 12 V.

In order to avoid overheating of the electromagnet, the air brakes should not be held in the extended position longer than 7 min. If the electromagnet operation limit is exceeded, it may burn off, the air brakes will be retracted and another extension will be impossible.

## 5.2. Power supply system

The MiG-15bis has a 28.5 V single-wire electrical system powered by a 3.0 kW GSR-3000 generator. Energy sources for the aircraft are the GSR-3000 generator and one 12A-30 battery. Both energy sources are parallel-connected to the common bus.

For connection to the ground power source, there is a special plug, the current from which is supplied to the aircraft power circuit and to the starter panel to supply the ST-2 starter.

The power source for the ground engine start is a special ground trolley that consists of four batteries with a total capacity of 200 ampere-hours. Ground start from an onboard battery is impossible.

To indicate disconnection of the GRS-3000 generator from the aircraft power circuit, there is a signal lamp on the instrument panel:



It should be noted that the generator disconnects from the circuit when engine RPM is lower than 4.000.

Electric consumers on the aircraft are listed in Table 5.1:

**Table 5.1**

No.	System or equipment
1	Components of electrical engine starting system: electrical starter; startup pump; ignition coil; two starter nozzle valves; starting panel.
2	Isolating valve
3	Two fuel pumps
4	Components of the fire extinguishing system: squibs of fire extinguisher bottles; signal lamp; signal lamp check button; fire detector

No.	System or equipment
5	Electrical measuring devices: fuel meter with alert signal; three-pointer indicator; fuel pressure gauge
6	Artificial horizon
7	Distance-reading gyromagnetic compass
8	Radio equipment
9	Elevator and aileron trim tab electrical control mechanisms
10	Weaponry
11	Gun camera
12	Gunsight
13	Bomb and external tank jettison system
14	Navigation lights
15	Headlights
16	Internal cockpit lighting: ultraviolet illumination; cabin lights
17	Landing gear and flaps position indication lamps
18	Electric flare pistol
19	Pitot probe and clock heating

**In case of full loss of power, the listed systems and equipment will not be available.**

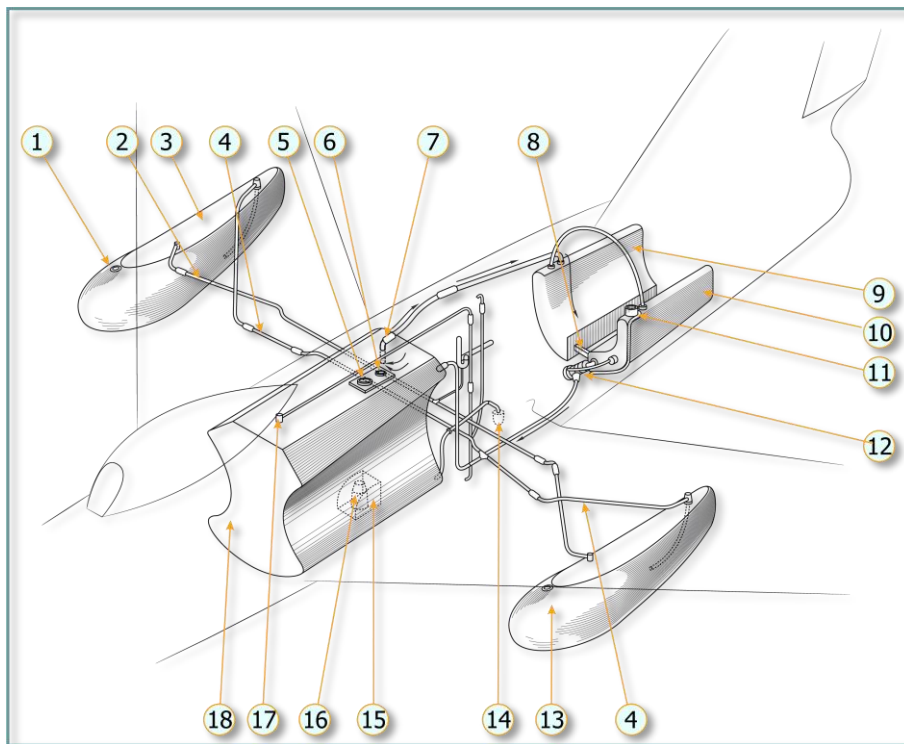
The electrical circuit and its components are protected by bimetal automatic circuit breakers (ACB) installed on two electrical distribution boxes on the left and right panels in the cockpit. On the left electrical distribution box there are all the circuit breakers corresponding to the engine, on the right one – those for various systems of the aircraft.

As the aircraft does not have an alternating current system, the power circuit of each power consumer has its individual inverter (115 V and/or 36 V).

In case of generator failure, the battery power will be sufficient for a 24-26 min daytime flight in cloudy weather conditions or for a 20-23 min nighttime flight. If you leave all consumers enabled, the battery will supply them for 10-14 minutes only.

### 5.3. Fuel system

The purpose of the fuel system is onboard storage of fuel and its continuous supply to the engine. A schematic of the fuel system is shown in Figure 5.3.



**Figure 5.3. MiG-15bis fuel system**

- |   |   |
|---|---|
| 1. Drop tank fueling inlet                          | 10. Rear left fuel tank                             |
| 2. Pressurized air line                             | 11. Rear left fuel tank filling inlet               |
| 3. Right drop tank                                  | 12. PTsR-1 fuel pump<br>(rear tank to forward tank) |
| 4. Fuel line to forward tank                        | 13. Left drop tank                                  |
| 5. Forward tank fueling inlet                       | 14. Engine filter                                   |
| 6. Fuel quantity probe                              | 15. Negative G compartment                          |
| 7. Forward tank fuel return line                    | 16. PNV-2 booster pump                              |
| 8. Rear left and right fuel tank<br>connecting line | 17. Drain line nozzle                               |
| 9. Rear right fuel tank                             | 18. Forward main tank                               |

The fuel system consists of two tanks with a total capacity of 1410 liters. The forward tank (tank 1) contains 1250 liters, the rear one (tank 2) 160 liters. The rear tank consists of two halves – left and right – each of which has a capacity of 80 liters. The fuel quantity is monitored (not fully) by the fuel quantity probe (6) installed in the forward tank and able to measure the fuel quantity from 0 to 1050 liters. When only 300 liters of fuel are remaining in the forward tank, the fuel meter illuminates the 300 liters warning lamp (see [4.2.11](#)) on the instrument panel.

### ***Operation***

With the PTsR-1 fuel pump (12), the fuel is continuously transferred from the rear left tank (10) to the forward tank (18), and from the upper part of the forward tank through the collector of returned fuel (7) to the rear right tank (9) (this is done to prevent overpressure in the forward tank). At the bottom of the forward tank there is a negative G compartment (15). From there, fuel through the booster pump (16) is supplied to the engine filter (14). Note that in case of a full power loss, if there still is fuel in the forward fuel tank, the fuel will continue to be supplied to the engine due to the suction pressure created in the fuel lines by the high pressure fuel pumps that are rotated by the gearbox.

The pump (12) is located in the engine bay and is attached to the engine body. Near the pump there is a pump sensor of the SD-3 type. When the pump is on and the pressure in it is above 0.3 kg/cm<sup>2</sup>, the signal lamp in the cockpit is off. When the fuel in the tank has been consumed and the fuel pressure becomes less than 0.3 kg/cm<sup>2</sup>, the lamp illuminates. After that the pump must be turned off.

*NEGATIVE G COMPARTMENT* (15) with a capacity of 26 liters is located below the front tank and provides fuel for negative G flight including inverted flight for 15 sec.

### ***Fuel tank sequencing***

In the forward fuel tank, the return fuel collector (7) is set to a certain level. Therefore, the fuel is taken from the tanks in the following sequence:

- 345 liters from the forward tank;
- from the rear tank (until it will be empty);
- remaining fuel from the forward tank.

At the beginning, when the forward and rear tanks are full, the fuel transferred into the forward tank is drained through the return fuel collector and the drain pipe into the rear tank (9). The required tank sequencing is respected.

### ***System of external tanks***

The external fuel tank system consists of:

- external tanks (3), (13), [Figure 5.3](#), with a capacity of 300, 400 or 600 liters;
- air duct that supplies air under excessive pressure at 0.4 kg/cm<sup>2</sup> from the engine compressor to the tanks (2);
- fuel supply line to forward tank (tank 1) (4) with a floating valve that controls fuel supply (located under gauge (6)).

When the aircraft flies with external tanks, the fuel is consumed from the tanks in the following sequence:

- 100 liters from forward tank.
- All fuel from external tanks.
- 245 liters from forward tank.
- All fuel from rear tank.
- Remaining fuel from forward tank.

When the ПОДВ. БАКИ (EXTERNAL DROP TANKS) warning light on the armament control panel **goes out**, it means that the process of supplying fuel from external tanks is on:



This warning light can be turned on/off using the СИГНАЛИЗ. ПОДВ. БАКОВ (DROP TANKS ALARM TRIGGERING) switch:



In other words, the behavior of the warning light is as follows:

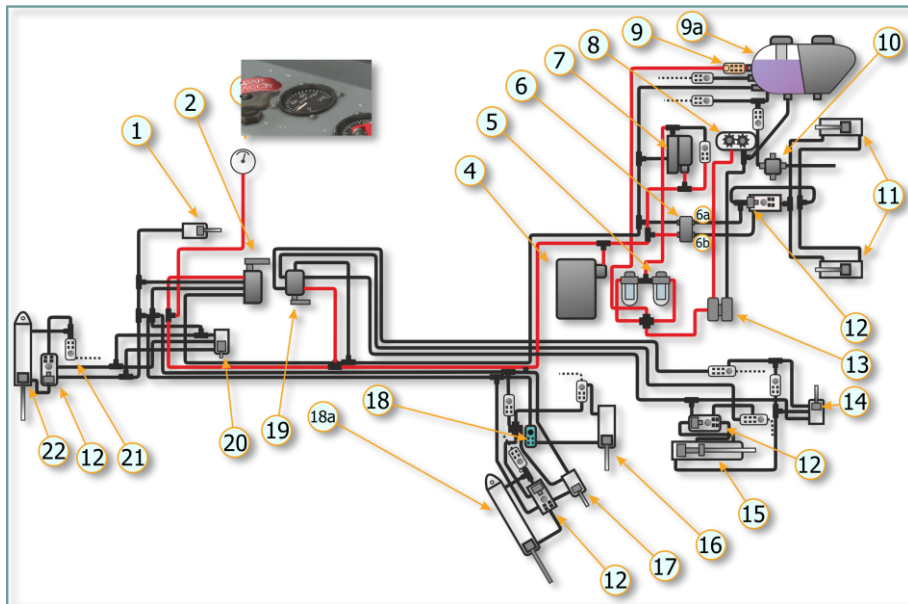
- If there is fuel pressure in the line, the warning light is off.
- If there is no fuel pressure in the line, the warning light is on.

*Note.* At low engine RPM (less than 6.000 RPM) the ПОДВ. БАКИ (EXTERNAL DROP TANKS) warning light may illuminate in spite of the presence of fuel in external tanks. This is due to insufficient pressurization of fuel in the external tanks by the air from the compressor along the line [Figure 5.3, 2.](#)

#### **5.4. Utility hydraulic system**

The utility hydraulic system supplies the landing gear, the flaps and the speedbrakes. The hydraulic fluid is an alcohol-glycerin mixture. The maximum pressure of the hydraulic fluid in the system is 135-140 kg/cm<sup>2</sup>.





**Figure 5.4. Utility hydraulic system**

- |   |  |
|---|--|
| 1. Automatic braking cylinder                                 | 11. Air brake control cylinders            |
| 2. Landing gear valve   | 12. Hydraulic lock valve                   |
| 3. Hydraulic system pressure gauge for 250 kg/cm <sup>2</sup> | 13. Ground pump valve                      |
| 4. Hydraulic accumulator                                      | 14. Flaps locking cylinder                 |
| 5. Filter   | 15. Flaps cylinder                         |
| 6. Air brake solenoid control valve                           | 16. Landing gear bay doors cylinder        |
| 6a. Air brake extension line                                  | 17. Main landing gear locking cylinder     |
| 6b. Air brake retraction line                                 | 18. Equalizing valve                       |
| 7. Relief valve   | 18a. Main landing gear retraction cylinder |
| 8. Pump   | 19. Flaps distributing valve               |
| 9. Check valve  | 20. Nose gear locking cylinder             |
| 9a. Hydraulic fluid tank                                      | 21. One-way valves (12)                    |
| 10. Pressure reducing valve                                   | 22. Nose gear retraction cylinder          |

### 5.4.1. Description of hydraulic system elements

#### *Landing gear control system*

The landing gear control system includes the landing gear valve (2), extension and retraction cylinders (18a, 22), three landing gear locking cylinders (17,

20), hydraulic locks (12), one-way valve (21), equalizing valve (18), landing gear bay doors cylinder (16) (see [3.1.6](#)).

#### ***Flaps control system***

The [flaps control system](#) includes flaps cylinder (15), hydraulic lock (12), one-way valve (21), and flaps locking cylinder (14).

#### ***Speedbrake control system***

The [speedbrake control system](#) includes air brake control cylinders (11), hydraulic lock (12), and depressurization valve.

#### ***Hydraulic system valves***

The landing gear valve (2) and the flaps distributing valve (19) in the neutral position separate the hydraulic system supply line from the return line and from the extension and retraction cylinders.

The speedbrake valve (6) does not have a neutral position. In the initial position, this lever connects the speedbrake retraction line with the supply line, and the extension line with the return line. For speedbrake extension, this valve connects the high pressure line with the air brake extension line (6a). For speedbrake retraction, it connects the high pressure line with the air brake retraction line (6b).

#### ***Relief valve***

The relief valve (7) controls the pressure in the system and serves for switching the pump into the idle mode when a component in the system has finished its operating cycle.

#### ***Hydraulic accumulator***

The hydraulic accumulator (4) ensures precise operation of the relief valve, eliminates pulsations in the system and serves as a source of energy when the pump is inoperative, for example, for the retraction of the flaps on the ground after landing.

### **5.4.2. Hydraulic system operation**

The pressure in the hydraulic system is created by the pump (8) which is driven by the engine gearbox. The schematic shows the moment when the relief valve

(7) is in the operating cycle, the pump is increasing the pressure in the system, the valves are closed. The high pressure lines are shown in red.

When the engine is on, the pump moves the hydraulic fluid from the hydraulic reservoir (9a) into the system until the pressure in the system reaches 135-140 kg/cm<sup>2</sup>. At this moment, the automatic relief valve (7) opens the flow of the hydraulic fluid into the tank, and the pump goes into the idle mode. The hydraulic accumulator (4) ensures a quick closure of the check valve (same as 21 in the scheme) behind the relief valve. In the idle mode, the pump moves the hydraulic fluid in a short closed loop: tank – pump – filters – relief valve – tank. In the idle mode, the pressure does not exceed 5 kg/cm<sup>2</sup>. From the value of 140 kg/cm<sup>2</sup> the system pressure behind the check valve gradually decreases because of leakages. When the pressure has decreased down to 80-90 kg/cm<sup>2</sup>, the automatic relief valve closes the access for the fluid into the tank, and the fluid again starts coming into the system behind the check valve.

To monitor the performance of the hydraulic system, there is a hydraulic pressure gauge (3) for up to 250 kg/cm<sup>2</sup>, on the right side horizontal panel in the cockpit right side (see [Right side horizontal panel](#)), which indicates pressure in the system behind the check valve.

Thus, if the pressure indicated by the pressure gauge is below 80 kg/cm<sup>2</sup> while there are no cockpit inputs for the hydraulic system, this means that the pump did not start working due to the failure of the relief valve (7) or another failure in the hydraulic system. In a similar way, pressure growth above 150 kg/cm<sup>2</sup> can be an indication of the failure of the automatic relief valve. In this case, at a pressure of 165–170 kg/cm<sup>2</sup> the safety valve (9) will direct a part of the hydraulic fluid into the hydraulic reservoir, so the pressure in the system will remain at a level of 165–170 kg/cm<sup>2</sup>.

When one of the levers (2, 19, 6) is ON, the pressure in the system drops rapidly, the relief valve puts the pump into operating mode so that hydraulic fluid flows into the cavities of the cylinders moving the pistons. After the operating cycle of the cylinders is finished, the pump supplies the fluid only to the hydraulic accumulator. Here the pressure rapidly grows to 140-145 kg/cm<sup>2</sup> and the relief valve again switches the pump into the idle mode.

To ensure reliable operation of the pump at high altitudes, there is an additional supply system.

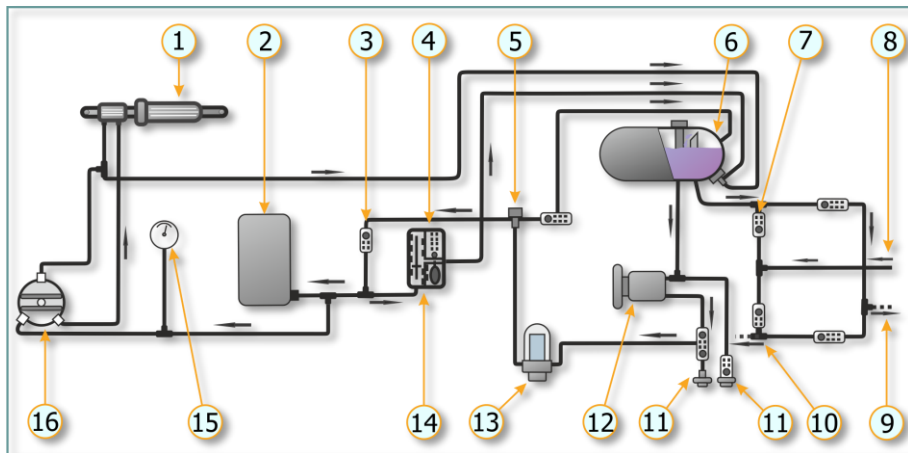
### **5.5. Lateral control hydraulic system**

The purpose of the lateral control hydraulic system ([Figure 5.5](#)) is to relieve the loads in the transverse (roll) control line. The hydraulic booster has its own separate hydraulic system (with its own reservoir, its own pump), the purpose

of which is to continuously supply oil under a certain pressure to the booster, for aileron control.

The maximum pressure in the system is  $60 \pm 5 \text{ kg/cm}^2$ .

The reservoir of the hydraulic booster and the reservoir of the utility hydraulic system are put into a common housing (i.e. they share one common housing, but are functionally independent from each other).



**Figure 5.5. Lateral control hydraulic system**

- |   |  |
|---|--|
| 1. Hydraulic booster                              | 10. To the utility hydraulic system tank |
| 2. Hydraulic accumulator                          | 11. Ground pump valves                   |
| 3. One-way valve                                  | 12. Hydraulic pump                       |
| 4. Relief valve                                   | 13. Filter                               |
| 5. Idle ground operation pressure gauge connector | 14. Relief valve                         |
| 6. Hydraulic fluid tank                           | 15. Hydraulic pressure gauge             |
| 7. One-way valve                                  | 16. Shut-off valve                       |
| 8. Compressor bleed air                           |  |
| 9. Drain line                                     |  |

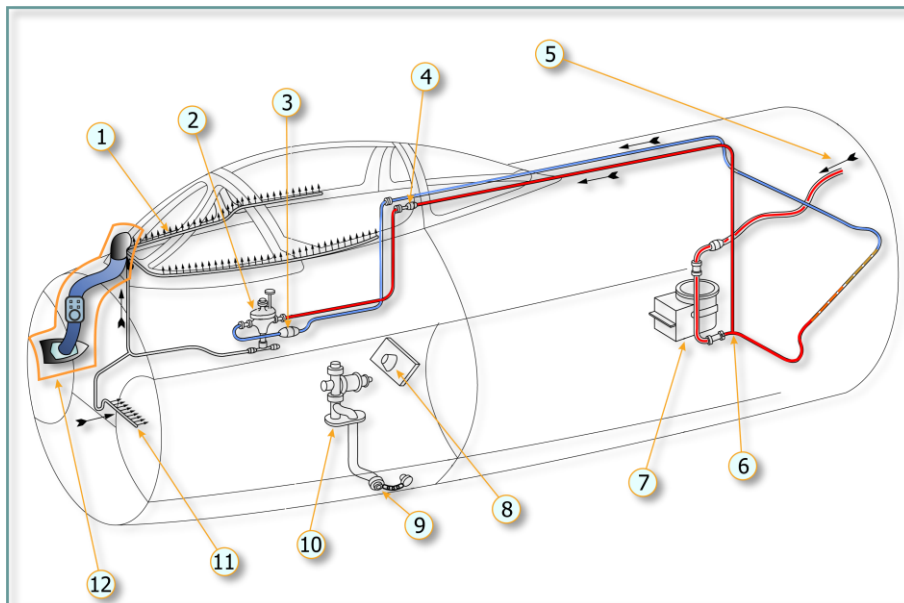
### ***Booster hydraulic system operation***

The pressure in the system is created by the pump continuously operating from the engine (12) (see [Figure 5.5](#)). The pump is supplied from the hydraulic fluid tank (6). The hydraulic fluid is supplied under pressure into the system through the filter (13) and the one-way valve (3) charging the hydraulic accumulator (2), and then through the valve (16) to the hydraulic booster slide valve and into the hydraulic booster itself. The fluid from the hydraulic booster flows into the tank. If the pressure in the system reaches  $60 \pm 5 \text{ kg/cm}^2$ , the relief valve (14) switches the pump into the idle mode, and the hydraulic booster continues to be supplied by the hydraulic

accumulator. Due to the movements of the piston of the hydraulic booster and due to leakage, the pressure in the system drops. As the pressure is dropping, the pump switches again to the operating mode and supplies the fluid into the hydraulic booster and thus increases the pressure. The hydraulic booster system is monitored through the pressure gauge (15) on the left panel. To turn off the system (if required) and to switch the aileron control into manual mode, there is a shut-off valve (16) that cuts the supply line from the hydraulic booster. The hydraulic booster shut-off valve must always be open except for the cases when it is required to cut the oil supply.

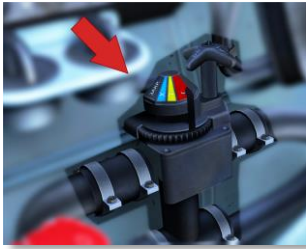
## 5.6. Environmental control system

The environmental control system (ECS) is used to provide the pilot with normal environmental conditions (cockpit temperature and pressure) when performing flight at all operational altitudes. The ECS consists of air supply and supplementary ventilation subsystems. A simplified schematic of the ECS is shown in Figure 5.6.

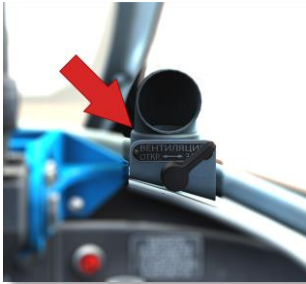


**Figure 5.6. Environmental control system**

- |   |   |
|---|---|
| 1. Windshield blower and cockpit blowing duct       | 7. Filter   |
| 2. Cockpit air supply valve with slide valve        | 8. KRP-48 safety check valve                        |
| 3. Cold air line OKN-30 one-way valve               | 9. Air drain line with plug (removed before flight) |
| 4. Hot air line OKN-30 one-way valve                | 10. RD-2I-220 pressure regulator                    |
| 5. Air supply from engine                           | 11. Leg warming blower                              |
| 6. Line splitter into hot and cold air supply lines | 12. Auxiliary ventilation system                    |

***Cockpit objects connected to the ECS***

Cockpit pressurization supply valve with slide valve (Figure 5.6, 2) (on the right side, right below pilot seat)



Auxiliary ventilation system (Figure 5.6, 12) output duct (to the right from gunsight) with shut-off valve

***Cockpit pressurization supply system operation***

Air is supplied to the cockpit from the engine compressor (5). Warm air from the engine compressor is fed through the air filter (7) and one-way valve (4) to the cockpit air supply valve (2) and further to the blowing duct (1), located under the front windshield and along the canopy sides. The purpose of the blowing duct is to use air flowing into cockpit for windshield and canopy defogging.

Cockpit air is supplied from the engine compressor only. Hot and cold air generation is achieved by splitting a common line into two parts and selectively insulating only one of them. The common line from the engine (5) before splitting (6) has thermal insulation. After splitting, the part of the line which is responsible for cold air supply (blue color in the schematic), has no thermal insulation. This part is longer and routed through the tunnel in front of the engine. Here the non-insulated pipe is being constantly blown by cold air, thus the air inside is being cooled. The other part, which after splitting is used for hot air supply (red color in the schematic) continues its path with thermal insulation and because of that the air inside this pipe remains hot.

### ***RD-2I-220 pressure regulator operation***

As the cockpit is closed hermetically and forced air is being taken from the compressor, excessive air is being bled by the RD-2I-220 cabin pressure regulator (10).

At flight altitudes up to 2000 m (corresponding approximately to 596 mmHG) the RD-2I-220 pressure regulator connects the cockpit with the atmosphere. There is no pressure difference between the actual altitude and the "cockpit altitude". From 2000 m and above, a system of bellows and valves (built-in in RD-2I) starts operating. It closes extensive air bleeding and the difference between outside atmospheric pressure at flight altitude and in-cockpit pressure increases. At 8.800 m altitude and above, the pressure difference stops growing and remains the same (about 220 mmHG). Thus, the pressure in the cockpit for 8.800 m altitude corresponds to 4.200 m flight altitude. For 15.000 m the cockpit pressure corresponds approximately to 6.600 m altitude.

The RD-2I-220 pressure regulator has both automatic and manual control modes. In the simulation, however, only the automatic regulation is implemented.

In case of failure of RD-2I-220 operation and a pressure difference of more than 200 mmHG, a safety valve (8) activates. The KRP-48 safety valve starts air bleeding when excessive pressure difference reaches  $255 \pm 10$  mmHG.

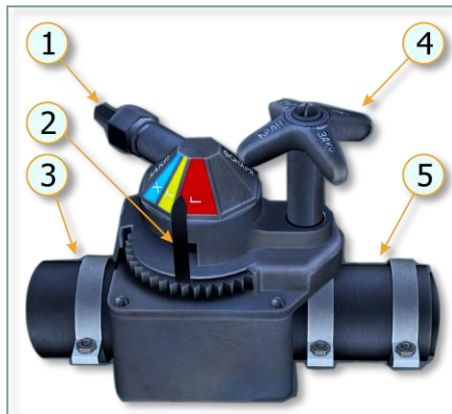
The pilot has to control the pressure difference using the pressure gauge (4.2.18). If at 9.000 m the pressure difference is more than  $0.3 \text{ kg/cm}^2$ , the pilot has to shut off the supply valve. Exceeding the allowed pressure difference limit means that the KRP-48 safety valve is out of order.

### ***Cockpit air supply valve***

The cockpit air supply valve (2) has two main positions: ГОРЯЧИЙ (HOT) and ХОЛОДНЫЙ (COLD). In the HOT position, air is fed from the engine compressor into the cockpit through the hot air supply line. In the COLD position, air is taken from the compressor as well, but flows through the cold part of the line.

The cockpit air supply valve (Figure 5.7) is an element of both the air supply and the pneumatic system. It is a cylindrical plug valve, by means of which the pilot can regulate (control) the cockpit air supply.





1. Canopy pressurization line
2. Valve setting pointer
3. Cold air line
4. Valve
5. Hot air line

**Figure 5.7. Air supply valve**

The cockpit air supply valve is connected to the cockpit pressurization line, which supplies air at a pressure of  $2.9 \pm 0.2 \text{ kg/cm}^2$  into the cockpit pressurization hose (from the pneumatic system). To bleed air from the pressurization hose before opening the canopy, there is a special opening in the valve, through which air bleeds when the valve is completely closed.

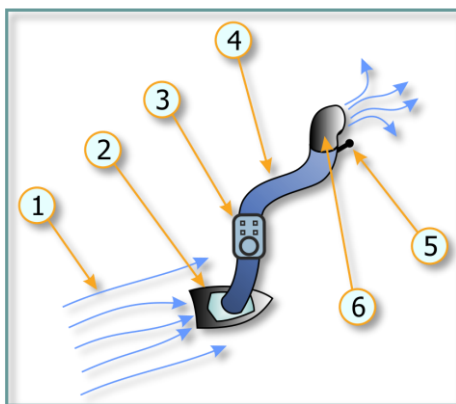
The valve is controlled by a handle via round gears. When the valve setting pointer (2) is in the rightmost position, the canopy is depressurized. Moving the pointer  $10^\circ$  to the left starts air feeding into the cockpit pressurization hose via line (1), but the cockpit is not supplied with air yet. With continued movement to the left, cockpit air supply is started via line (3) and air continues to flow to the pressurization hose. Turning the setting pointer to  $70^\circ$  fully opens the cold air supply. Further opening of the valve decreases the amount of cold air supply and increases hot air supply (via line 5). At  $120^\circ$  cold air supply is shut off completely and hot air supply is fully opened.

Turning the valve (4) counter-clockwise moves the valve setting pointer (2) clockwise and vice versa. The following sequence occurs when turning the valve (4) clockwise (i.e. the valve setting pointer is turned counter-clockwise) from the OFF to the FULL ON position:

- No cabin air supply, canopy seal deflated
- Cabin air supply, canopy seal inflated
- Cold air flow starts
- Maximum cold air supply
- Cold and hot air mixed
- Maximum hot air supply

### ***Cockpit auxiliary ventilation system***

The MiG-15bis is equipped with an auxiliary ventilation system (12), which can be used by the pilot to ventilate the cockpit when flying at low altitudes in hot outside temperatures. In the simulation, the auxiliary ventilation system can be used to ventilate out cockpit smoke in case of fire.



1. Air stream flowing through the engine right tunnel
2. Air intake mounting flange
3. Non-return valve
4. Air line
5. Ventilation valve
6. Air system output duct, located in cockpit on the right side from the gunsight

**Figure 5.8. Auxiliary ventilation system**

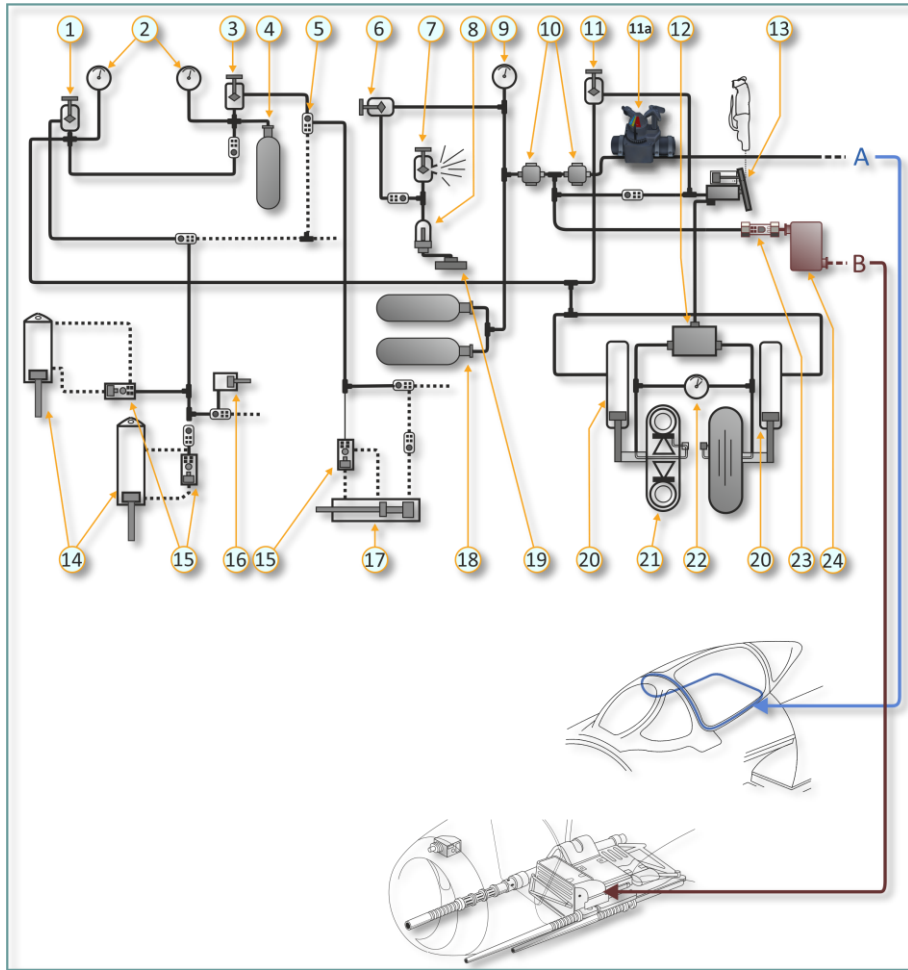
The ventilation system includes the air intake (2), installed in the right tunnel of the engine (on the right, in front of windshield), a non-return valve (3), an air line (4) and the valve used for turning on/off ventilation (5).

When the cockpit pressurization system is turned on, closing of the ventilation valve is not necessary, because the ventilation system has a check valve, which automatically turns off the ventilation line in case of excessive pressure.

The auxiliary ventilation system is effective for altitudes from 0 to 2000 m.

## 5.7. Pneumatic system

The pneumatic system of the aircraft is divided into main and emergency systems.



**Figure 5.9. MiG-15bis pneumatic system**

- |                                       |                                      |
|---------------------------------------|--------------------------------------|
| 1. Emergency gear extension valve     | 13. PU-7 braking valve               |
| 2. Emergency pressure gauges          | 14. Landing gear extension cylinders |
| 3. Emergency flap extension valve     | 15. Hydraulic lock                   |
| 4. Emergency flap compressed air tank | 16. Landing gear bay doors cylinder  |

5. Emergency and one-way valves
6. Charging valve
7. Cockpit air pressurization valve
8. Air filter
9. Pneumatic system pressure gauge
10. RV-50 and RV-3 pressure reduction valves
11. Emergency air tanks charging valve
- 11a. Cockpit air supply valve (from environmental control system) and slide valve (from pneumatic system) in a common casing
12. PU-8 differential valve
17. Flap extension cylinder
18. Main air tanks
19. Onboard charging connector
20. Emergency air tanks inside the landing gear struts
21. Main landing gear wheel (with drum and braking pads)
22. Braking system dual-pointer pressure gauge
23. Gun reload shut-off valve
24. Gun reload receiver
- A – air supply for canopy strip seal
- B – air supply for gun reloading system

### 5.7.1. Pneumatic system purpose, structure and operation

The pneumatic system provides:

- main landing gear brakes control;
- air supply for canopy strip seal (the cockpit pressurization line) (A);
- gun reloading (B).

The main air system consists of:

- onboard charging connector (19);
- air filter (8);
- charging valve (6);
- cockpit pressurization valve (7);
- cockpit air supply valve (11a), which opens the slide valve for filling the cockpit pressurization line with air;
- pressure gauge (9) on horizontal panel on the right side of the cockpit;
- two four liters air tanks (maximum allowed pressure is 150 kg/cm<sup>2</sup>) (18)
- air pressure reduction valves RV-50 (10, on the left) and RV-3 (10, on the right);
- braking system (elements 12, 13, 22).

***Cockpit objects related to the pneumatic system***

1. Charging valve ([Figure 5.9](#), 6)
  2. Cockpit pressurization valve ([Figure 5.9](#), 7)
- Located on the right behind pilot seat



cockpit air supply valve ([Figure 5.9](#), 11a), which opens the slide valve for filling the cockpit pressurization line with air



pneumatic system pressure gauge ([Figure 5.9](#), 9) on horizontal panel on the right side of the cockpit

gear brake lever ([Figure 5.9](#), 13)



dual-pointer braking system pressure gauge ([Figure 5.9](#), 22) on [left side](#)



gun reloading panel on the right side of the cockpit.



### ***Pneumatic system operation***

During ground maintenance the pneumatic system is recharged via an onboard charging connector (19). For recharging, the valves (1, 3, 7, 11) have to be closed and the valve (6) has to be opened. The air tanks have to be recharged to a pressure not less than 110 kg/cm<sup>2</sup>. After recharging, the valve (6) shuts off and the pneumatic system is ready for operation.

If there is a need to check cockpit pressurization without starting the engine, one must do the following: Close the canopy. Open the cockpit air supply valve (11a), which incorporates a slide valve. This valve opens (when air supply valve is opened for more than 10°) air flow from RV-3 pressure reducing valve (10, on the right) to the cockpit pressurization line. If the pressure in this line reaches 2.5-3 kg/cm<sup>2</sup>, the cockpit is considered hermetically sealed. Now it is necessary to create excessive pressure in the cockpit. For that purpose, air from the ground air compressor is fed into the cockpit via the main system charging socket (19) and opened cockpit pressurization valve (7). When some pressure difference is reached, the cockpit is checked for air leakages.

In the simulation, there is no need for the player to use valves (6) and (7), because ground maintenance of the pneumatic system is not modeled.

Cockpit decompression (blowing off from the pressure seal) is performed by turning the cockpit air supply valve (11a) counterclockwise to the side of closing. Simultaneously, the air from the seal will come out through the open hole.

The pressure reduction valve (10, on the left) is tuned for 50 kg/cm<sup>2</sup>. The air from this valve is fed to:

- braking system, PU-7 valve (13);
- via shut-off valve (23) and receiver (24) into the gun reloading system (B);
- to emergency air tanks recharging valve (11);
- via RV-3 pressure reducing valve to canopy pressurization valve (A).

### ***Braking system***

The braking system includes the PU-7 braking lever (13), PU-8 differential (12), dual-pointer pressure gauge (22) installed on the left side of the cockpit and a network of pipes and hoses that connects these devices with the wheel brakes. The MiG-15bis has drum brakes. The brake valve is controlled with a lever on the stick or by an automatic braking cylinder during gear retraction. Air to the PU-7 valve is fed from the RV-50 pressure reduction valve with pressure 50 kg/cm<sup>2</sup>. The pressure behind the reduction valve depends on pressure effort on its piston and can reach up to 12 kg/cm<sup>2</sup>. The PU-8 differential is used to provide separate wheel braking during taxiing and ground runs.

**Warning!** In case of pneumatic system malfunction, gear braking after landing can be done using air from gear emergency air tanks. To do that, it is necessary to open emergency air tanks recharging valve (11). In this case the braking system can access air from the emergency air tanks inside the landing gear struts.

### ***Brake control***

The aircraft stick has a lever that is connected via cable with the PU-7 valve lever. Braking is performed at 2 different pressure modes: the first one at 8 kg/cm<sup>2</sup> and the second one at 11-12 kg/cm<sup>2</sup> (braking before rolling and emergency braking). To enable the second braking mode, pull the braking lever further to trigger a special spring mechanism.

### 5.7.2. Emergency pneumatic system purpose, structure and operation

The emergency pneumatic system provides:

- emergency gear extension
- emergency flaps extension.

It consists of:

- emergency air tank charging valve (11)
- emergency gear (20) and flap (4) extension tanks
- emergency pressure gauges (2)
- emergency valves (1, 3)
- emergency air tanks inside the landing gear struts.

Emergency gear (1), flap (3) valves and corresponding pressure gauges are installed on the right horizontal panel. To reduce the effort needed for opening, the valves have special foldable levers.

The emergency air tank charging valve (11) is located on the right side, to the right from the pilot seat.

#### *Cockpit objects related to emergency pneumatic system*



emergency air tank charging valve ([Figure 5.9](#), 11)  
(on the right side, to the right from the pilot seat)



emergency pressure gauge and gear extension valve ([Figure 5.9](#), 2, 1)





emergency pressure gauge and flaps extension valve (Figure 5.9, 2, 3).

### ***Emergency landing gear extension (with explanations)***

Emergency extension of the landing gear is achieved using compressed air from the emergency air tanks, which are stored in the inner space of the main landing gear struts. The pressure in the emergency air tanks is 50 kg/cm<sup>2</sup>, their total capacity is 5.5 liters.

The procedure for emergency landing gear extension is as follows:

1. Turn the landing gear valve in НА ВЫПУСК (EXTENSION) position to enable liquid displacement from retraction cavities.
2. Open the gear locks using the mechanical cables (non-operating hydraulic system cannot open gear locks, keeping gear in retracted position).
3. Open the emergency valve, located on the right panel.

When the emergency valve is opened (1), air flows to the main gear cylinder through the emergency check valve in distribution box and to the nose landing gear via the emergency hydraulic lock valve. During this process ball valves of hydraulic locks shut off under air pressure. Hydraulic fluid under air pressure flows to air tank from internal cavities via gear valve and stop blocking filling of landing gear extension cylinders with air, landing gear extends. When the landing gear is fully extended, the air pressure seen on the emergency pressure gauge stabilizes at 25-28 kg/cm<sup>2</sup>.

Further, pressure reduces due to leakage via hydraulic lock ball check valves. Nevertheless, it does not impact on landing gear extension, because fully extended rod is fixed by ball lock, which can be opened only by feeding hydraulic mixture in на уборку (RETRACTION) position.

4. When emergency landing gear extension is completed, it is necessary to close the emergency gear valve and set the gear valve in neutral position.

### ***Emergency flaps extension***

Emergency extension of the flaps is also achieved with compressed air. The compressed air used for emergency extension of the flaps is stored in a separate 4-liter air tank (4).

1. Set flaps lever to НЕЙТР (NEUTRAL) or Вып. 55° (EXTEND 55°) to provide the possibility of liquid displacement from retraction cavities.

In the hydraulic circuit on the 20° flap extension line before lock cylinders special emergency valves are installed for emergency opening of mount locks connected to the emergency extension system in parallel with emergency valves on hydraulic locks.

## 2. Open emergency flaps valve.

When the emergency flaps valve is opened, the air in the cylinders flows through the hydraulic locks emergency valves. In the extended position, flaps are held by air pressure and hydraulic locks.

After emergency extension of flaps, the pressure indicated on the emergency pressure gauge has to be around 35-40 kg/cm<sup>2</sup> initially. Leakages should not exceed 2 kg/cm<sup>2</sup> per 10 minutes. This can be checked on the emergency flaps pressure gauge.

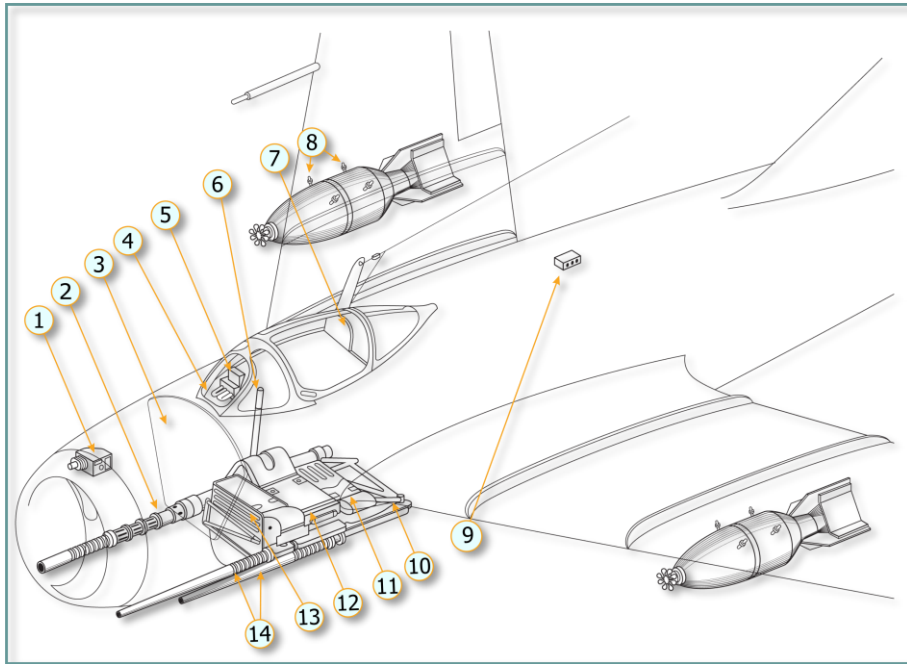
Emergency landing gear and flaps extension systems are not connected with each other (because of one-way valves).

In case of pneumatic system failure, reloading of the guns will not work.

## ***5.8. MiG-15bis armament***

The aircraft's armament system is used to deliver weapons to the combat operation area with the following aiming and combat employment.

The system consists of gun armament, bombs, ASP-3N gunsight, S-13 gun camera, pilot armored protection and signal flare launcher.



**Figure 5.10. MiG-15bis armament**

- |                                  |                                     |
|----------------------------------|-------------------------------------|
| 1. S-13 gun camera               | 9. Flare launcher (flare cartridge) |
| 2. N-37D cannon                  | 10. Gun carriage                    |
| 3. Armored plate on frame № 4    | 11. NR-23 rear gun ammunition box   |
| 4. Armored canopy windscreen     | 12. N-37D ammunition box            |
| 5. ASP-3N gunsight               | 13. Armored plate on frame № 5      |
| 6. Fire control buttons on stick | 14. NR-23 cannons                   |
| 7. Armored headrest              |                                     |
| 8. Bomb racks                    |                                     |

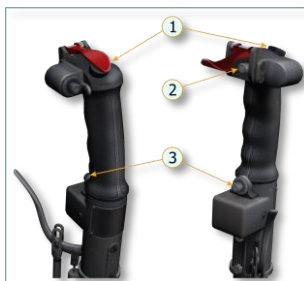
### Cockpit objects connected to the weapon system



ASP-3N gunsight  
(over the instrument panel)



Armament control panel  
(under the instrument panel)



Fire buttons on the stick for firing guns and bombs release:  
 1. N-37D gun trigger  
 2. NR-23 guns trigger  
 3. Tactical bombs release button



Guns reloading panel  
(left side of the cockpit)



Flare launcher control panel  
(left side of the cockpit)



Armament automatic circuit  
breakers (right electrical panel)

### 5.8.1. Gun armament

#### *Purpose and structure of gun armament*

The gun armament of the MiG-15bis (Figure 5.11) is used against aerial and ground targets.



Figure 5.11. MiG-15bis gun armament

It consists of:

- 2 x 23 mm NR-23 (14) cannons with 80 rounds per gun
- 37 mm N-37D (2) with 40 rounds

- gun undercarriage (10)
- gun reloading system
- electrical circuits controlling gun firing and reloading
- two gun triggers on the stick
- armament control panel under the instrument panel (lamps signaling firing readiness)
- cannon reloading panel on the left side of the cockpit
- automatic circuit breakers for armament on the right electrical panel.

The ASP-3N gunsight is used for aiming. Fire control is electrical with two standard buttons, located on the stick. The button located on top of the stick is used to fire the N-37D cannon and the button located on the front side of the stick (the side opposite to the pilot) to fire both NR-23 cannons. Gun reloading is performed by an electrical pneumatic system (see below). There are three signal lamps on the armament control panel to indicate that the cannons are armed and ready to fire. Shot cartridges and metal links are removed from the aircraft via removing hosepipes.

#### ***Main characteristics of 23 mm NR-23 automatic cannons***



Characteristic	Value
Year	1944
Caliber, mm	23
Weight shell/cartridge, kg	0,2 / 0,311
Rate of fire, rounds per minute	800–950
Muzzle velocity, m/s	
FI shell (fragmentation incendiary)	680
AP-I shell (armor-piercing incendiary)	680
Shell weight/(explosive, incendiary mixture), kg	
FI shell	0,2 / 0,015
AP-I shell	0,2 / 0,007
Armor penetration, mm armor (normal to the piercing surface)	25 at 200 m
Cannon weight, kg	39
Barrel length, mm	1450

Characteristic	Value
Total length, mm	1985
Width, mm	165
Guaranteed barrel life, shots / maximum burst length, shells	6000 / 80
Pneumatic pressure needed for cannon reloading, kg/sm <sup>2</sup>	not less than 35

### ***Main characteristics of 37 mm N-37D automatic cannon***



Characteristic	Value
Year	1946
Caliber, mm	37
Shell weight, kg	0,735
Rate of fire, rounds per minute	400
Muzzle velocity, m/s	
FI-T shell (fragmentation incendiary tracer)	690
AP-I-T shell (armor-piercing incendiary tracer)	675
Armor penetration (AP-I-T), mm armor normal to the piercing surface	40 at 400 m
30° to the normal to the piercing surface	20 at 400 m
Cannon weight, kg	103
Barrel length, mm	1361
Total length, mm	2455
Pneumatic pressure needed for cannon reloading, kg/sm <sup>2</sup>	35–70

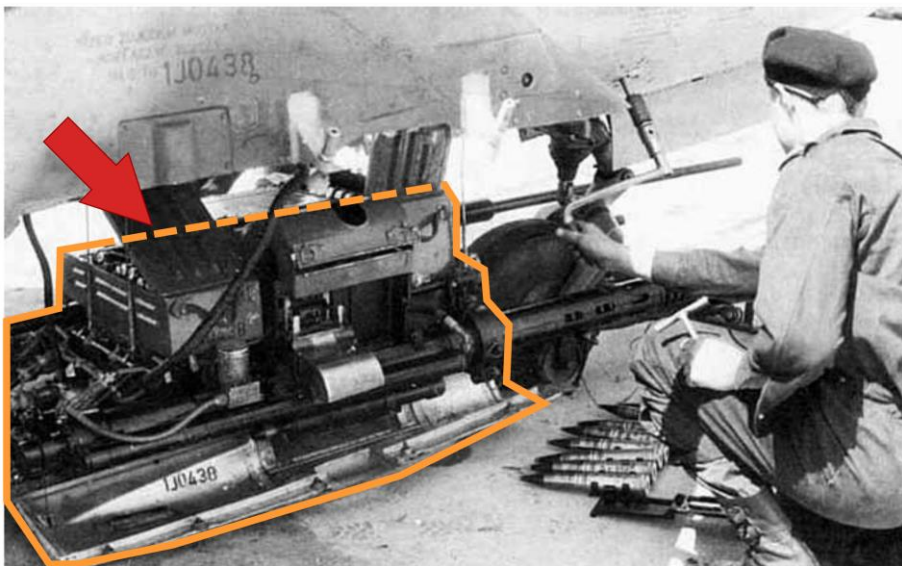
N-37D automatics operation is based on the use of cannon recoil energy together with short distance barrel movement (short recoil operation). The main part of the energy is used to move moving parts, overcome friction forces and compress springs. The remaining energy is absorbed by hydraulic and muzzle brakes. The barrel channel is locked by a piston type lock. Reloading is pneumatic.

During N-37D experimental shooting in October 1944, AP-I-T shells shot from 400 m distance showed the following results: when the shell entry angle was normal to the penetrated surface, a 45 mm armored plate was pierced by 60% of the shells, 40 mm armor was pierced by all shells; 30° to normal to the penetrated surface was not pierced at all (the shells did not even stick in the armor).

From 200 m distance, the 40 mm armor was not pierced at an angle of 20° and 45 mm at an angle of 15°. At realistic armor entry angles (30–45° to normal), the N-37D cannons could not pierce armor with a thickness of more than 20–30 mm even on close distances.

### ***Guns undercarriage***

The guns undercarriage (Figure 5.12.) is a framed bearing construction developed for compact placement in the aircraft's fuselage and comfortable ground maintenance of cannons, ammunition boxes, reloading systems and wires of electrical circuits responsible for fire and reloading control.



**Figure 5.12. MiG-15bis gun undercarriage with all equipment installed**

In all cases of undercarriage extension, lifting and removal, weapon convergence is not broken. Extension of the undercarriage for ground maintenance is not modeled in the simulation.

### ***Fire and reloading electrical circuits***

These circuits are designed to operate with electrical trigger (shot initiation) and reloading systems electrical part. They are modeled completely.



### ***Guns reloading system***

This system is developed for electrical-pneumatic loading of the guns for first shooting and reloading when jammed. It uses compressed air from the pneumatic system and direct current from the aircraft's electrical circuit.

System components are: shut-off valve, receiver, three EK-48 electrical-pneumatic valves (one for each cannon), three power cylinders, non-return valve for N-37D, hoses and pipes.

Guns are being reloaded in an electro-pneumatic way with the three buttons located on the gun reloading control panel:



Button layout corresponds to weapon layout as "seen" from pilot seat. The left and central buttons are used for reloading the NR-23 and the right one for the N-37D. By pushing a button on the gun reloading control panel, the pilot enables an electromagnet of the EK-48 valve. To guarantee correct reloading, it is necessary to keep the button pushed for at least 3 seconds.

The EK-48 electrical-pneumatic valve is a device combining a retractile electromagnet and a pneumatic valve. The electromagnet opens the valve and after that compressed air from the aircraft pneumatic system flows simultaneously into the cylinders of the percussion lock mechanism and into the gun belt loader. When the button is released, the electromagnet turns off, valve switches are being pushed by a spring, and air from cylinders bleeds into the atmosphere.

Air is fed from the main pneumatic system to the EK-48 valve through a shut-off valve and receiver (see [Figure 5.9](#), line B).

When reloading is finished, the red gun ready lights on the armament control panel ([Figure 4.11](#)) illuminate, indicating that the cannons are ready to fire.



The minimum voltage required for reloading is 22 V.

The shut-off valve is needed when the undercarriage with the guns is being extended and removed from the aircraft.

A two liter receiver is installed the near cannons and responsible for efficient supply of the working cylinders with compressed air. A receiver is a cylinder tank, which has one input and two outputs.

### 5.8.2. Bombs and related equipment

Bombs are used for attacking non-armed ground targets. Bombs and related equipment includes (in this simulation):

- two BD2-48MiG bomb racks (one per wing)
- two FAB-100M bombs ([Figure 5.13](#)) or two FAB-50 bombs
- bomb control panel
- tactical bomb release button on the stick ([Figure 4.3](#), 4)
- automatic circuit breakers for emergency bomb and drop tank release on the right electrical panel.



Figure 5.13. FAB-100 bomb under the right wing

The bomb control panel ([Figure 4.11](#), 6–10) is part of the airplane armament panel.



Bombs can be released either using the main release circuit (tactical release) or the emergency release circuit. Bombs can be released with the "взрыв" (ARMED) setting (tactical or emergency release) or the "невзрыв" (NON-ARMED) setting (tactical or emergency release).

*STANDARD PROCEDURE FOR TACTICAL BOMB RELEASE:*

1. Switch on the БОМБЫ (BOMBS) automatic circuit breaker on the right electrical panel;
2. Switch on the main bomb electrical release circuit switch on the bomb control panel labeled ТАКТИЧЕСКИЙ СБРОС ВКЛЮЧЕН НА ВЗРЫВ (TACTICAL RELEASE, BOMBS ARMED);



The two green load presence lamps and the red bombs armed lamp should light up:



3. Release the bombs by pressing the tactical release button on the control stick. When the bombs are released, the green lamps will go out.

Note: The red bombs armed lamp labeled ВЗРЫВ (DETONATION) will stay on until the ТАКТИЧЕСКИЙ СБРОС ВКЛЮЧЕН НА ВЗРЫВ (TACTICAL RELEASE, BOMBS ARMED) switch is switched off.

*PROCEDURE FOR EMERGENCY RELEASE OF ARMED BOMBS:*

1. Switch on the АВАРИЙНЫЙ СБРОС БАКОВ (EMERGENCY DROP TANK RELEASE) automatic circuit breaker on the right electrical panel.
2. Switch on the main bomb electrical release circuit switch on the bomb control panel marked with ТАКТИЧЕСКИЙ СБРОС ВКЛЮЧЕН НА ВЗРЫВ (TACTICAL RELEASE, BOMBS ARMED). The two green load presence lamps and the red bombs armed lamp should light up.

3. Release the bombs by opening the emergency release button safety cover |LAlt + D| and pressing the emergency release button |LCtrl + D|.



#### *EMERGENCY RELEASE OF NON-ARMED BOMBS:*

*Note:* If bomb emergency release is required for a safe landing and the bombs are not dropped on a target, the bombs have to be released non-armed. For this, the АВАРИЙНЫЙ ВЗРЫВ (EMERGENCY BOMB ARMING) switch has to remain in the down position. All other pilot actions are as described above.

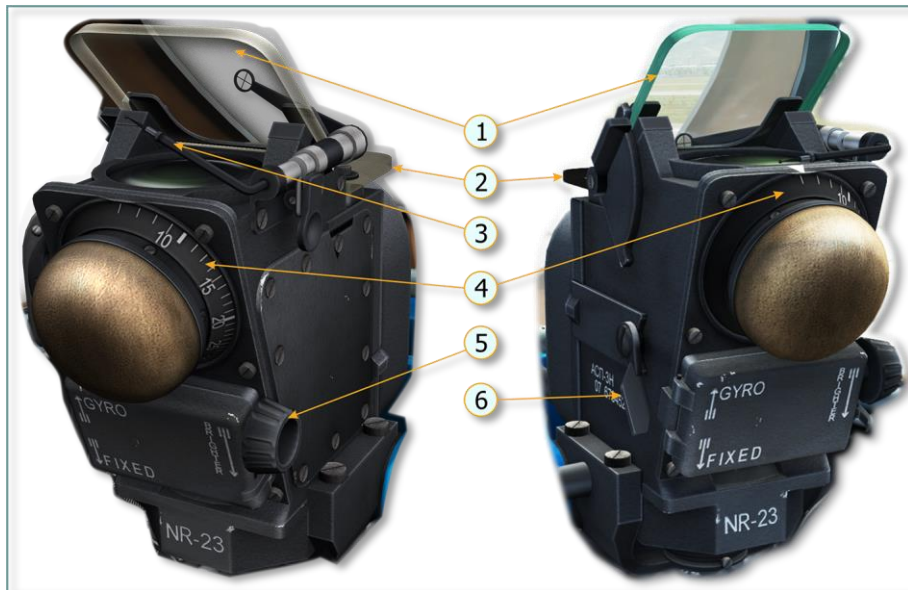
### **5.8.3. ASP-3N gunsight**

To assist aiming during shooting, the automatic gyro ASP-3N gunsight (Figure 5.14) is installed in the aircraft.

It contains:

- aiming head with distance rheostat and carrying console;
- automatic altitude input mechanism (automatic altitude input device);
- barreter current stabilizer;
- distribution box;
- filter.

The barreter current stabilizer, distribution box and filter are implemented as parts of the gunsight and not described separately.

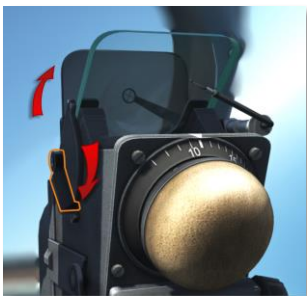


**Figure 5.14. ASP-3N gunsight aiming head**

- |                               |                             |
|-------------------------------|-----------------------------|
| 1. Reflector                  | 4. Target wingspan knob     |
| 2. Sight dimmer               | 5. Brightness knob          |
| 3. Mechanical backup gunsight | 6. Gunsight gyro cage lever |

(1) *REFLECTOR*. The reflector is used to project the aiming reticle and grid in the pilot's field of view.

(2) *SIGHT DIMMER*. The sight dimmer provides comfortable aiming conditions, when sunlight falls into the gunsight's field of view. It can be toggled with a mouse click or [|RAIt + L|](#);



(3) *MECHANICAL BACKUP GUNSIGHT*. The backup gunsight is used for aiming in case of main gunsight failure or damage. It is activated with a mouse click or |LAlt + M|.



(4) *TARGET WINGSPAN KNOB*. This knob is used to set the target base (usually the wingspan) in meters. It can be operated with the mouse wheel or the |,| |/| keys.

(5) *BRIGHTNESS KNOB*. This knob allows setting a comfortable brightness of both the reticle and the fixed grid (day – bright, night – dimmed). It can be rotated with the mouse wheel or the |RAlt + O| |RCtrl + O| keys. As depicted on the ЯРЧЕ (BRIGHT) label, rotating the knob down increases the brightness.

(6) *GUNSIGHT GYRO CAGE LEVER*. This lever is used to cage the gunsight's gyro to prevent gyro malfunctions during high-G maneuvering, takeoff and landing and in cases when it is easier to aim using the fixed grid (at distances less than 200 meters). The lever can be toggled with the mouse or the |J| key. When the lever is in the up (ГИРО – GYRO) position, the gyro is uncaged. In the down (НЕПОД / НЕПОДВИЖНЫЙ – FIXED) position, the gyro is caged.

The gunsight head with the distance rheostat is installed in front of the pilot and before the armored windshield.

### **General description of ASP-3N**

The main characteristics of the ASP-3N gunsight are listed in Table 5.2.

**Table 5.2**

<b>Characteristic</b>	<b>Value</b>
Aiming distance, m	180 - 800
Target lead angle	0-8°
Target wingspan, set with corresponding knob, m	7-45
Mechanical gunsight circle size, mils	17,5
Operating voltage, V	26±10%

Characteristic	Value
Consumed power, W: with heating	up to 120
without heating	60
Angular size of distance measurement circle (range), mils	17,5 – 132 (from 1° to 7°)
Gunsight weight, kg	8,1

The gunsight has optics of collimator type with a backlight, which allows aiming independently from conditions of target and background light.

A target distance measurement device allows distance ranging from 180 and up to 800 meters with a target size (wingspan) from 7 to 45 meters.

The gunsight has simple functions for calculating a firing solution and automatically computes target lead angles for the fixed onboard armament. Therefore, in the gunsight head's field of view there are two aiming marks: a fixed one with a fixed-radius circle and a central dot and a moving one (gyro) with a ranging circle consisting of 8 diamonds.

*Note.* Here the word "moving" is regarded only as the capability of diamonds to converge in the center or diverge. In the GYRO mode and in presence of the roll of an aircraft, the whole aiming mark (both outer circle and diamonds) moves within the gunsight.

Aiming is performed by aircraft maneuvering and thereby the gyro compensated sight moves from the center of field of view towards visible target trajectory. Target lead angle ( $\psi_{wpm}$ ) is computed based on target relative angular velocity ( $\omega_t$ ) and shell time of flight for a given target distance ( $T_r$ ):

$$\psi_{wpm} = \omega_t T_r$$

The time of flight for a given target distance is calculated for ballistics of a particular weapon. The distance ranging rheostat of the ASP-3N gunsight is tuned for the NR-23 automatic cannon.

### ***ASP-3N gunsight "computer" operation principle***

To calculate correct target lead angles for shooting, it is necessary to know the target's angular velocity relative to the gunsight, distance to target, density of air and shell ballistics for the current air density.

To calculate the angular velocity, gunsight gyro precession is used, which is enabled by the gyro cage lever (6). To calculate the distance, the linear size



of the target (target base) and the angular size of the target have to be entered. The target base (usually the wingspan) is entered manually by the pilot with the help of the wingspan knob (4). Angular size of the target is constantly being corrected by twisting the throttle handle and framing the target with the diamonds' internal vertices.

Thus, for the given values of shell ballistics, computed target distance, its angular velocity and air density (automatic altitude input device exists in the system for that purpose), the correct target lead angle is being calculated.

### ***General description of the pilot operation during aiming***

During target engagement, the pilot observes the target through the reflector of the gunsight collimator head. Also in the pilot's field of view is the distance measuring ring formed by eight diamonds. The distance measuring ring changes its size when the pilot twists the ranging handle mounted on the throttle handle. In addition to the distance measuring ring, a constant radius ring with a central dot is also seen.



During target pursuit the pilot has to maneuver the airplane to keep the central dot on a target. Besides that, the pilot has to constantly frame the enemy aircraft with the ranging circle (diamonds) by twisting the throttle handle.

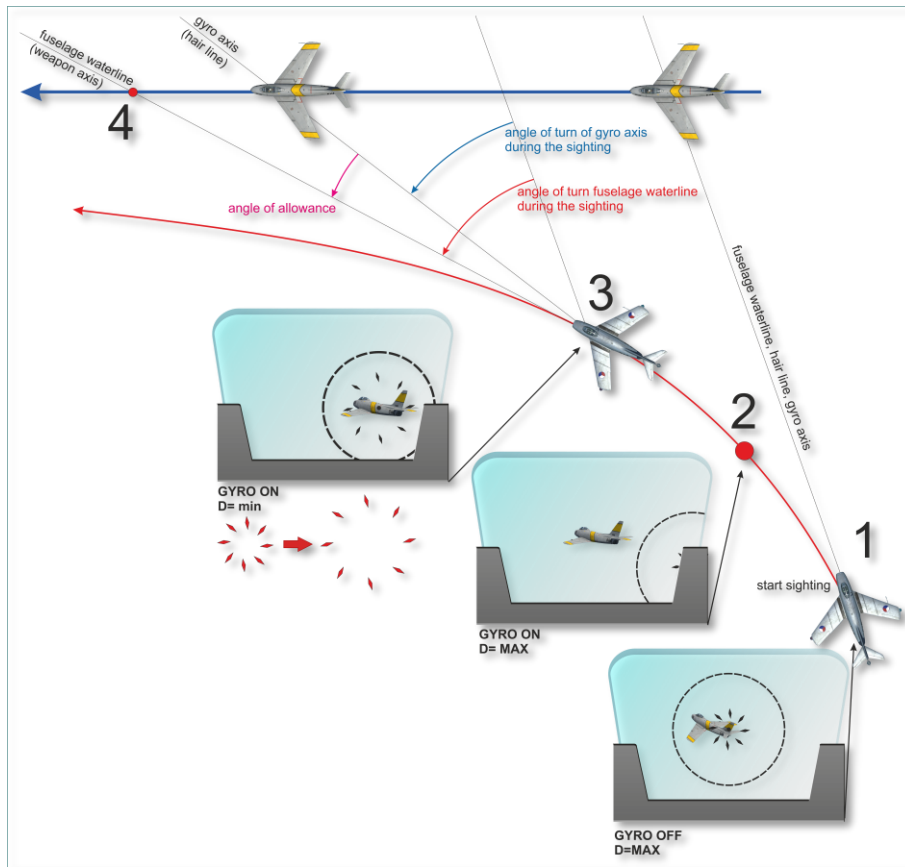
The relative angular velocity of the target is being automatically measured and entered into the computing part of the gunsight by the three-axis gyroscope during target pursuit due to gyro precession.

The rate of precession is changed via the ranging rheostat. The rheostat control is mounted on the throttle handle.



Twisting the handle through a cable changes the operating parameters of the ranging rheostat, which in turn impacts on rate precession of gyroscope. Mirror, projecting grid image and attached to one of gyro axis, deflects at larger or smaller angle, based on rheostat parameters. Gunsight grid image shifts into gunsight field of view in such a way, that pilot in order to keep central dot of gyro sight (sight with 8 diamonds) on target has to "carry weapon axis out" in front of target velocity vector. Target leading angle depends on all mentioned above factors.

Figure 5.15 explains the aiming technique with the use of the gyro gunsight:



**Figure 5.15. Aiming technique with the use of the gyro gunsight**

**Point/Position 1.** Start of an engagement. Gyro is caged, the pilot observes the target through central gunsight mark. Distance to target "Дальность" is set to 800 m (for example).

**Point/Position 2.** Pilot uncaged gunsight gyro and turned aircraft to keep target in field of view. Since in point 2 aircraft got angular velocity gunsight gyro precession begins. For entered target distance (800 m) gunsight computer calculated maximum leading angle, which at certain value of angular velocity during turn can move aiming mark out of gunsight field of view. Aiming mark will be seen behind target (gunsight reflector view for point 2).

**Point/Position 3.** Pilot reduced distance on rheostat to a minimum value (diamonds dispersed). The gunsight computer reduced angular adjustment, aiming mark moved closer to gunsight center, making it easier for the pilot to keep the target inside the area framed by the diamonds. When the target is correctly framed and seen inside internal diamonds vertices, the correct aiming angle (angle of allowance in the schematic) will be automatically computed. Angle of allowance is the angle between the gyro axis pointed at target and the fuselage axis (weapon axis).

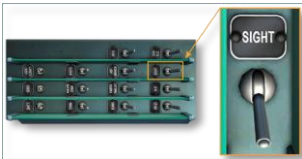
**Point/Position 4.** Place where shells hit target if fired.

Notes.

1. When being blended by the sunlight, the sight dimmer (2) can be used |RAIt + L| to ease aiming.
2. To reduce distance calculation errors due to target visible size change under different shooting angles, average angle (1/4) for the most probable shooting angles (from 2/4 to 0/4) is taken into account. Therefore, there is no need to do an additional adjustment based on target view angle. Distance ranges for correct distance ranging device operation for typical targets engagement see [Figure 10.1](#).

### ***Preparing gunsight for aerial target engagement***

1. Before shooting, it is necessary to switch on the CB ПРИЦЕЛ (SIGHT) switch |LAlt + LCtrl + R| on the right electrical panel 10 minutes before gunsight usage:



2. Gyro must be caged by pushing the gyro cage lever in the down position |J|:



3. Uncover the Guns Safety Cover on the control stick (set trigger guard to the armed position) **|LCtrl + Space|**.



4. When a target is identified, it is necessary to set the target base on the target wingspan knob **|,|, |/|** (for example, the wingspan of an F-86 is 12 m) and uncage the gyro **|J|**:



5. Start closing the distance to the target, maneuvering the aircraft until the target is seen in the gunsight's field of view. This maneuver is normally performed at higher turn rates, where the gyro will deflect at larger angles and aiming circles and central dot can move out of the gunsight's field of view. To avoid this, it is recommended to set the minimum target distance by twisting the throttle handle **|.|**.



This action will provide an angle reduction of deviations reticle of sight regarding the aircraft waterline (because the computer assumes that the target is close and minimum angular correction is required).

6. Start pursuit, trying to combine the center of the diamond circle with the target. Simultaneously, the pilot must frame the target with the diamond circle by twisting the throttle handle |;|, |.|.

7. During target pursuit it is necessary to control the aircraft very smoothly so that the central dot is always kept on the target and using target distance twist on throttle handle constantly frame target contours by diamond circle.

8. Keep the target framed by the diamond circle for at least 1.5 -2 seconds and then open fire.

### **Warning.**

1. A correct target lead angle can be calculated only if the target wingspan is correctly set on the wingspan knob and the target is framed by the diamond circle, formed by the diamonds internal vertices. During maneuvering combat in case of big angular velocities or at distances less than 180 m, it is necessary to use the fixed grid. To do that, the pilot must move the gunsight cage lever into the НЕПОД (CAGE) position |LShift + J|. The fixed circle can be used as well in case of gyro malfunction.

2. In case of optical system or backlight lamp failure, the pilot must use the mechanical sight (3).

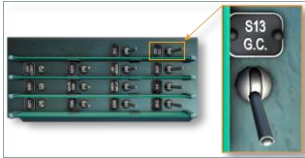
3. During engine startup, taxiing, takeoff and before landing, the pilot must cage and turn off the gunsight.

### **5.8.4. S-13 gun camera**

The S-13 gun camera, installed in the upper nose part of the fuselage, is used to control the results and the effectiveness of shooting.



The gun camera system consists of the S-13 gun camera itself and the Ф.П.-С13 (F.P.-S13) automatic circuit breaker |LAlt + LCtrl + 7| on the right electrical panel.



The gun camera is enabled while pressing any of the two gun triggers.

Camera operation is indicated by the gun camera status lamp, labeled Ф. К. П. (F. K. P., for "Fotokamera Pulemot" or gun camera) on the instrument panel, which illuminates if any of the two gun triggers is pressed.

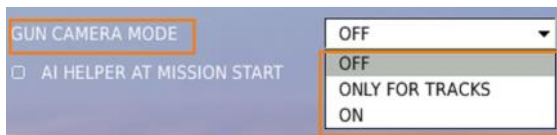


The main parameters of the S-13 are listed in Table 5.3.

**Table 5.3**

Parameter	Value
Number of frames in cartridge	150
Maximum photoshooting time	19
Photoshooting rate, frames/sec	7-10
Weight, kg	2

In the simulation, the gun camera recordings can either be seen during the game or afterwards in the track replay. This can be configured in the game settings with the three different options of the GUN CAMERA MODE feature:



- OFF – disabled, gun camera recordings are not shown
- ONLY FOR TRACKS – recordings will be shown only during track replay
- ON – recordings will be shown immediately during shooting (Warning: may cause stuttering on low-end hardware!).

Every time one of the gun triggers is pressed, a photo taken by the S-13 gun camera will be displayed in the track (Figure 5.16):



Figure 5.16. Photo taken by the S-13 gun camera

### 5.8.5. Armor

The armored protection consists of two 10 mm armored side plates ([Figure 5.10](#), 3, 13), a 10 mm armored headrest on the pilot seat (7) and a 64 mm armored canopy windshield (4). It is modeled by the degree of pilot survivability when he is hit by high-velocity fragments and bullets.

### 5.8.6. Flare launcher (signal flare cartridge)

The ЭКСП-46 signal flare launcher consists of the signal flare cartridge, installed on the right side of the tail part of the fuselage, and the signal flare remote control inside the cockpit.





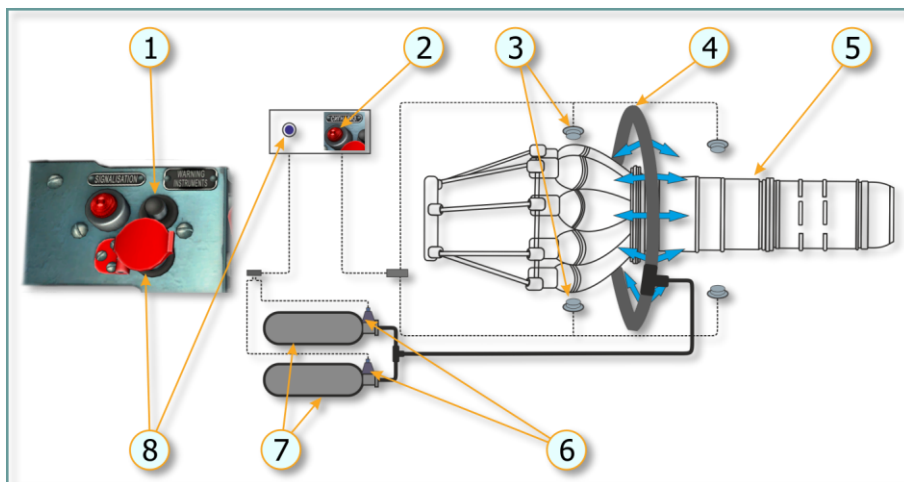
The cartridge is designed to be loaded with four 26 mm signal flares using electrical pyro charges. Flares can be launched with the signal flare remote control:



To launch a flare, it is necessary to set the СИГНАЛЬНЫЕ РАКЕТЫ (SIGNAL ROCKETS) switch in the ON position, and then press the flare launch button with the desired flare color. The minimum voltage for the flare launcher is 15 V.

### ***5.9. Fire extinguishing system***

The fire extinguishers (Figure 5.17) are designed to extinguish fire in the engine fire risk zone, i.e. in the zone where engine damage leads to an open flame. This zone encompasses the end of the combustion chambers and the turbine housing.



**Figure 5.17. MiG-15bis fire extinguishing system**

- |   |   |
|---|---|
| 1. Engine fire warning light test button                                    | 5. Engine   |
| 2. Engine fire warning light  | 6. Squibs   |
| 3. Fire detectors (4)   | 7. Extinguisher bottles<br>(filled with CO <sub>2</sub> ) |
| 4. Manifold with gas escape ports for<br>dissemination of extinguishing gas | 8. Engine fire extinguisher button                        |

The fire extinguishing system includes:

- two three-liter pressured bottles with CO<sub>2</sub> (7) and squibs (6);
- manifold with gas escape ports for dissemination of extinguishing gas (4);
- four fire detectors (3);
- ПОЖАР (FIRE) warning light with corresponding switch in the cockpit.

In case of fire, when the temperature in the engine compartment reaches 120-140°C, a signal from the fire detectors illuminates the ПОЖАР (FIRE) warning light.

#### ***Pilot actions in case of fire***

When the ПОЖАР (FIRE) warning light illuminates, it is necessary to:

1. Switch off the engine by stopping engine fuel supply. Shut-off fuel valve [\[End\]](#).

2. Enable the fire extinguishing system by pressing the engine fire extinguisher button (8) – remove the safety cover |RAlt + F| and then push the button |RCtrl + F|.

By pressing the button, each squib fires and moves a piston with a needle, which breaks the membrane and connects the CO<sub>2</sub> tanks with the extinguishing lines.

Released from the tanks, the gas is fed into the fire extinguishing manifold via fire extinguishing lines and kills the fire in the engine compartment by being sprayed over.

### 5.10. Oxygen supply system

The oxygen supply system (Figure 5.18) provides the pilot with the required amount of oxygen during a flight.

The system consists of oxygen bottles (tanks), tubing lines, pressure gauges, the KP-14 oxygen regulator and the KP-15 parachute oxygen set.

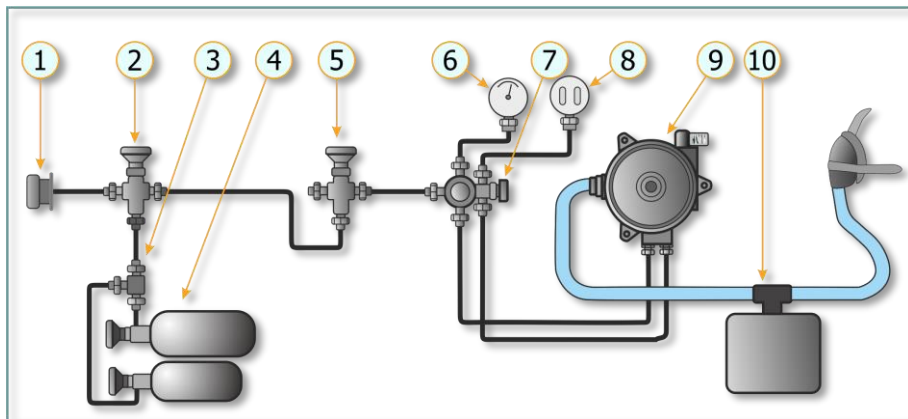


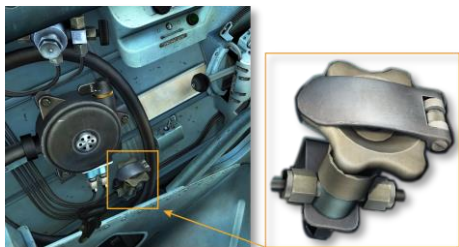
Figure 5.18. Oxygen supply system

- |   |  |
|---|--|
| 1. Charging connector                       | 7. KR-14 pressure relief valve with emergency supply valve |
| 2. Charging valve                           | 8. IK-14 oxygen flow indicator                             |
| 3. Adapter                                  | 9. KP-14 oxygen regulator                                  |
| 4. Oxygen bottles with 4 l and 2 l capacity | 10. KP-15 parachute oxygen set                             |
| 5. Oxygen supply valve                      |  |
| 6. MK-12 oxygen pressure gauge              |  |

(1) CHARGING CONNECTOR, (2) CHARGING VALVE, (3) ADAPTER – not implemented in this simulation.

(4) OXYGEN BOTTLES. Two oxygen bottles with a capacity of 4 l and 2 l respectively. Not visible in the simulation.

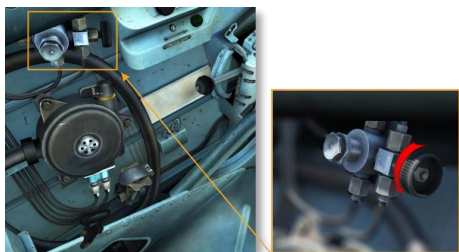
**Items in the cockpit related to the oxygen supply system**



(5) Oxygen supply valve  
([Figure 5.18](#), 5) on the left side



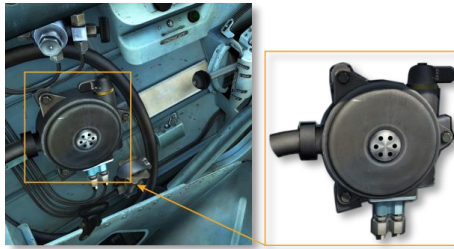
(6) MK-12 oxygen pressure gauge ([Figure 5.18](#), 6) on the instrument panel to the left



(7) KR-14 pressure relief valve with emergency supply valve  
([Figure 5.18](#), 7) on the left side



(8) IK-14 oxygen flow indicator  
([Figure 5.18](#), 8) on the left side



(9) KP-14 oxygen regulator  
([Figure 5.18](#), 9) on the left side

(10) *KP-15 PARACHUTE OXYGEN SET* is simulated as the ability to breathe after bailing out and not included in oxygen supply equipment tests.

### ***Oxygen supply system operation***

Oxygen is maintained at a pressure of 150 kg/cm<sup>2</sup> in the bottles (4). Under normal use, oxygen from the bottles flows to the charging valve (2) via a triple adapter, which connects the bottles with the onboard charging connector (1) for charging or with the onboard supply line for pilot use. From the charging valve, oxygen flows to the onboard supply valve (5). The supply line then leads to the KR-14 pressure relief valve (7), from which one of the lines leads to the pressure gauge (6), located on the left side of the instrument panel, while the other one leads to the KP-14 oxygen regulator (9).

The KP-14 regulator supplies the proper mixture of oxygen and air at all times, automatically supplying positive pressure-breathing at high altitudes. As altitude increases, the percentage of oxygen in the mixture increases as well.

A hose and an oxygen mask are attached to the regulator. The regulator is connected to the IK-14 oxygen flow indicator (8). The KR-14 pressure relief valve decreases oxygen pressure to 2-3 kg/cm<sup>2</sup> as it directs oxygen to the regulator. In the regulator, pure oxygen is mixed with surrounding cockpit air. The pilot breathes surrounding pressurized cockpit air up to a cockpit (pressurized) altitude of 2000 m, i.e. the pilot is not supplied with oxygen from the tanks by the oxygen supply system. At altitudes between 2000 and 8000 m, the percentage of oxygen in the regulator mixture begins to increase. At cockpit altitudes over 8000 m, the pilot is supplied with 100% oxygen.

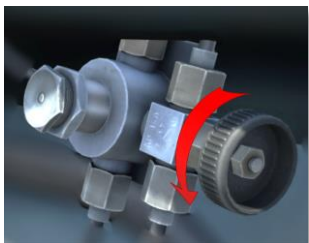
Operation of the KP-14 oxygen regulator requires opening the **diluter valve**:



Note : The simulation assumes that the pilot is always wearing the oxygen mask. Failure to open the diluter valve means the pilot will be starved of oxygen and may begin to **lose consciousness** in 30 - 40 seconds.

In addition to the KP-14 operation mode described above (mixing of the cockpit air with oxygen depending on the altitude), you can set the 100% oxygen mode by closing the air inflow. In other words, the long-governed oxygen inlet valve will supply pure oxygen. To do this, the air inflow switch must be reversed: "flag" means inside.

In case of fire or smoke in the cockpit at high altitudes, the use of emergency oxygen is recommended. To enable emergency oxygen flow, turn the emergency oxygen supply valve on the KR-14 pressure relief valve fully **left (counterclockwise)**.



In this case, oxygen is supplied continuously, bypassing the KP-14.

In case of cockpit depressurization at altitudes of up to 12000 m, the oxygen supply system provides a sufficient supply of oxygen to allow for a descent to safe altitudes. Depressurization at altitudes above 12000 m is fatal.

Preflight check of the oxygen supply system is described in section [7.1.2](#).

## ***5.11. Lighting equipment***

The lighting equipment is used to assist the pilot during night time flights and consists of both *COCKPIT LIGHTING* equipment and *EXTERNAL/EXTERIOR LIGHTING* equipment.

### **5.11.1. Cockpit lighting equipment**

The cockpit lighting equipment (Figure 5.19) is used to ensure good visibility of gauges and other cockpit objects when it's dark outside.



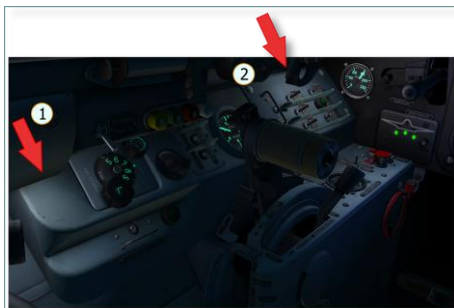
**Figure 5.19. Location of MiG-15bis cockpit light sources**

- |                                       |  |
|---------------------------------------|--|
| 1. White color cockpit lamp           | 4. Right ARUFOSH ultraviolet (UV) lamp |
| 2. KLS-39 white color cockpit lamp    | 5. KLS-39 white color cockpit lamp     |
| 3. Left ARUFOSH ultraviolet (UV) lamp |  |

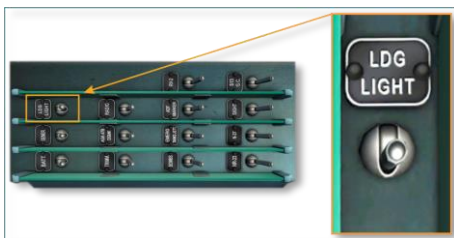
It consists of:

- one white color cockpit lamp illuminating the RSI-6M1 and the oxygen **gauge** (on the left) (1);
- one white color KLS-39 cockpit lamp illuminating the left electrical panel and control column (2);
- the left ARUFOSH ultraviolet (UV) lamp on knuckle lampholder (3);
- the right ARUFOSH ultraviolet (UV) lamp on knuckle lampholder (4);
- one white color KLS-39 cockpit lamp illuminating the right electrical panel (5);
- one RL-70 white cockpit lamp rheostat;
- two ARUFOSH UV lamp rheostats;
- automatic circuit breakers (ACBs) connected with the lights' electrical supply.

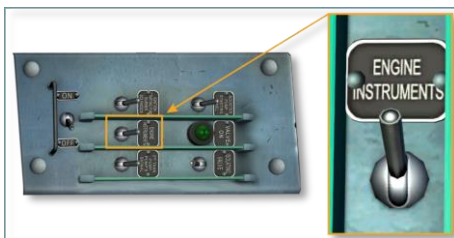
### *Description of cockpit objects related to interior cockpit lighting*



1. Location of white color lamp (1) illuminating the RSI-6M1 panel and the oxygen gauge. This lamp is enabled by the ФАРА (HEADLIGHT) ACB, lights continuously and cannot be regulated by the rheostats.
2. Installation place of white color lamp (2) illuminating the left electrical panel and control columns. This lamp is enabled by the ПРИБОРЫ КОНТРОЛЯ ДВИГАТЕЛЯ (ENGINE MONITORING GAUGES) ACB and regulated by the RL-70 rheostat.



The ФАРА (HEADLIGHT) ACB on the right electrical panel enables the headlight and the white color lamp (1) illuminating the RSI-6M1 panel and the oxygen gauge.



The ПРИБОРЫ КОНТРОЛЯ ДВИГАТЕЛЯ (ENGINE MONITORING GAUGES) ACB on the left electrical panel enables the white color cockpit lamps illuminating the left and right electrical panels.

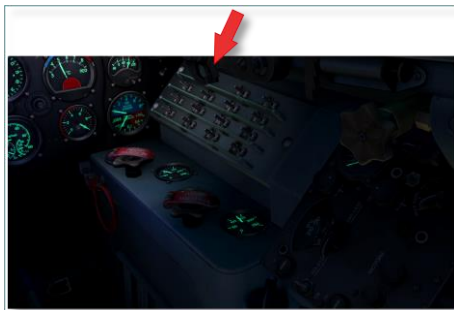




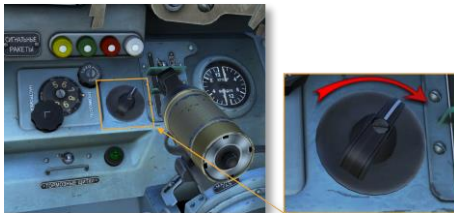
The left ARUFOSH lamp (3), illuminating the left and central parts of the instrument panel with UV rays, is enabled and controlled by the front RUFO-45 rheostat.



The right ARUFOSH lamp (4), illuminating the right and central parts of the instrument panel with UV rays, is enabled and controlled by the rear RUFO-45 rheostat.



Location of white color lamp (5) illuminating the right electrical panel. Enabled and controlled by the RL-70 rheostat.



The RL-70 white color cockpit lamp rheostat regulates the intensity of the two KLS-39 lamps illuminating the left and right electrical panels.



ARUFOSH RUFO-45 rheostats, regulating the intensity of the two ARUFOSH UV lamps.

Illumination intensity of all lamps (except the lamp which illuminates the RSI-6M1 and the oxygen gauge) is regulated by rotating the rheostats. The lamp illuminating the RSI-6M1 and the oxygen gauge is switched on by the ФАРА (HEADLIGHT) ACB. When switched on, this lamp shines with constant intensity. Since the ПРИБОРЫ КОНТРОЛЯ ДВИГАТЕЛЯ (ENGINE MONITORING GAUGES) ACB is enabled during the aircraft startup procedure, it is necessary to rotate the RL-70 rheostat clockwise (to the right) to enable white color illumination.

#### ***Operation peculiarity of ARUFOSH lamps***

In the "ignition" mode maximal voltage is applied to a coil and bimetallic strip. The coil warms up the bimetallic strip, vapor of mercury and argon, while the bimetallic strip opens the circuit after 15 sec of heating, an arc discharge occurs between the coil and a ring around it keeping the glow of vapor of mercury and argon. If maximal voltage is constantly applied to the lamp, coil blowing out may occur. For this reason, after lighting the lamp, you should turn the RUFO-45 regulator slightly to the left.

#### **5.11.2. Exterior lighting equipment**

The exterior lighting equipment (Figure 5.20) enhances visibility of the aircraft to other pilots during flight and provides runway illumination when taking off and landing at night.



**Figure 5.20. Airplane exterior at night with enabled exterior lights**

It consists of:

- three external navigational lights. As can be seen in Figure 5.20, the left one is red, the right one is green and the tail one is white;
- the AHO (ANO) exterior navigation lights switch. It has two positions: the left ВЫКЛ (OFF) position and the right ВКЛ (ON) position;
- the headlight, built in the airplane nose. The axis of the light beam is deflected to the left by 15°. The light spot is offset to the left and not directly in front of the aircraft to aid landing: When crossing the runway threshold and beginning to flare, the aircraft is in a slight nose-up position. In this position, it is not possible to look straight through the aircraft's nose to get a view of the ground - the pilot has to look to the sides and around the curve of the nose instead. Thus, the brightest part of the light is offset to illuminate the place where the pilot looks so that no light intensity is wasted. This is why, according to pilot instructions, the pilot should look to the left and slightly down during landing.
- the ФАРА (HEADLIGHT) switch.

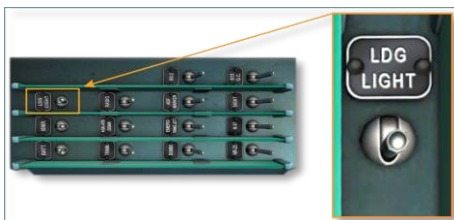
***Description of cockpit objects, related to exterior lighting equipment***



The exterior navigation lights switch, located on the left side of the cockpit, near the instrument panel, switches on all three navigation lights.



The  $\Phi$ APA (HEADLIGHT) switch is located on the upper left corner of the instrument panel.



The  $\Phi$ APA (HEADLIGHT) ACB, located on the right electrical panel, enables the headlight and the white color lamp, illuminating the RSI-6M1 panel and oxygen gauge, ([Figure 5.19](#), 1).

All lighting equipment is supplied by the aircraft's 27-29 V DC network.



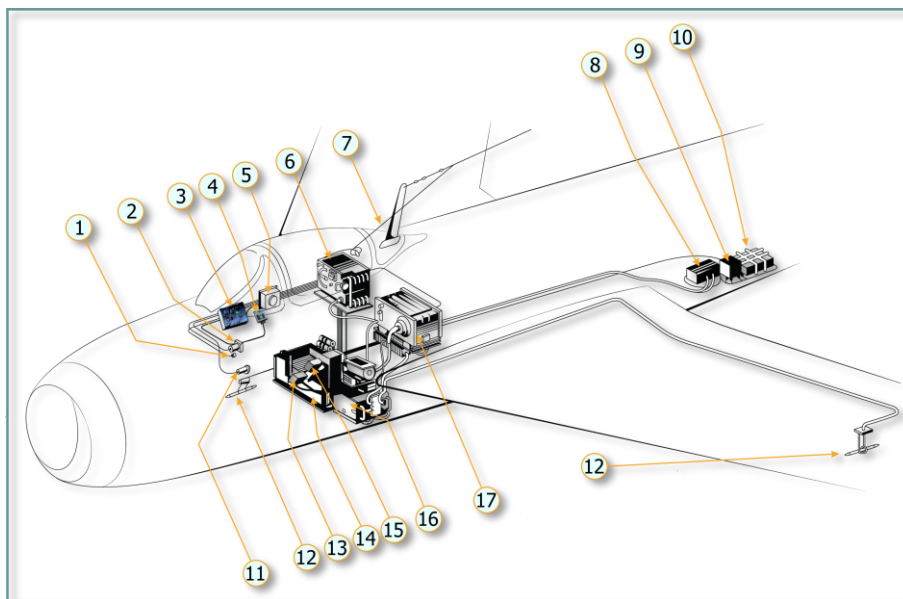
# 6

## RADIO COMMUNICATION AND RADIO ELECTRONIC EQUIPMENT

## 6. RADIO COMMUNICATION AND RADIO ELECTRONIC EQUIPMENT

The radio communication and radio electronic equipment of the MiG-15 provides communication between ATC, ground control centers and between airplanes. It can be used to determine aircraft position as well.

Location of the radio equipment is shown in Figure 6.1:



**Figure 6.1. Location of radio communication and radio electronic equipment**

- |  |  |
|--|--|
| 1. Marker beacon (MRP-48P system) fly-over signal lamp | 10. MRP-48P loop antenna                                   |
| 2. SUP-7 heading pointer of ARK-5 radiocompass         | 11. RV-2 radioaltimeter PRV-48 gauge                       |
| 3. ARK-5 radiocompass K-7 control panel                | 12. Two antennas of RV-2 radioaltimeter                    |
| 5. MRP-48P system buzzer                               | 13. ARK-5 near NDB frequency range selection control panel |
| 6. RSI-6K transmitter                                  | 14. ARK-5 direction finder receiver                        |
| 7. External transmitter antenna                        | 15. RSI-6M1 receiver DU-6 remote control panel             |
| 8. ARK-5 loop antenna                                  | 16. RV-2 radioaltimeter transceiver                        |
|  | 17. RSI-6M1 receiver                                       |

## 9. MRP-48P marker beacon receiver

### **6.1. Radio communication equipment**

The RSI-6 simplex shortwave transceiver (Figure 6.2), installed in the aircraft, is used for communication with ground services (ATC, flight controller, etc.) and between aircraft. The set consists of the RSI-6K transmitter and the RSI-6M1 receiver sets (both units are installed on the back side of the cockpit).

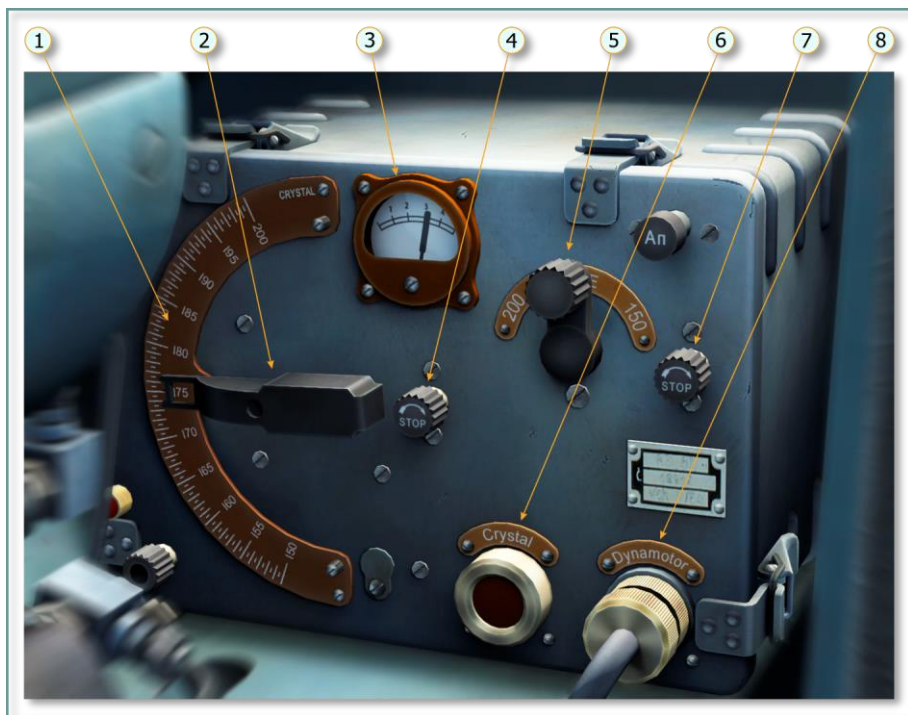


**Figure 6.2. RSI-6K transmitter (left) and RSI-6M1 receiver (right)**

In contrast with modern aircraft transceivers, the RSI-6 set allows tuning the transmitter to a different frequency than the receiver.

#### **6.1.1. RSI-6K transmitter**

The front panel of the transmitter (Figure 6.3) consists of several controls responsible for setting contour frequency, antenna tuning and tuning check:



**Figure 6.3. RSI-6K transmitter control elements located on the front panel**

- |                          |  |
|--------------------------|--|
| 1. Tuning scale          | 6. Socket for replacement quartz                         |
| 2. Transmitter wave knob | 7. Antenna tuning lock                                   |
| 3. Tuning meter          | 8. Umformer (electric current converter)<br>cable socket |
| 4. Transmitter wave lock |  |
| 5. Antenna tuning knob   |  |

(1) *TUNING SCALE*. This scale, labeled KBAPЛ (QUARTZ), displays the single supported wave band with the possible wave number range from 150 to 200.

(2) *TRANSMITTER WAVE KNOB*. This knob points to the selected wave number. The desired wave number value can be set by rotating the mouse wheel over the knob.

(3) *TUNING METER*. The tuning meter indicates the radio frequency current (in Amperes) in the antenna. It indicates precise antenna tuning on the transmitter frequency (when frequencies are matching exactly, the arrow will be deflected to the right on maximum value).



(4) *TRANSMITTER WAVE LOCK*. Turning this lock clockwise in the СТОП (STOP) position, locks the transmitter wave knob (2) in its current position to hold the tuned value even during strong vibrations. The lock can be toggled by mouse-clicking the lock.

(5) *ANTENNA TUNING KNOB* – rotating mouse wheel matches antenna contour parameters with transmitter frequency.

(6) *SOCKET FOR REPLACEMENT QUARTZ*. This socket, labeled Кварц (QUARTZ), contains a removable replacement Quartz crystal oscillator. Not simulated.

(7) *ANTENNA TUNING LOCK*. Turning this lock clockwise in the СТОП (STOP) position, locks the antenna tuning knob (5) in its current position to hold the tuned antenna contour parameters even during strong vibrations. The lock can be toggled by mouse-clicking the lock.

(8) *UMFORMER CABLE SOCKET* (electric current converter). This socket, labeled Умформер (UMFORMER), is used to connect the inverter power cable. Not simulated.

The transmitter has two frequency ranges: continuous and quartz stabilized. Both frequency ranges have “fixed waves” in the same ranges, i.e. from 3750 kHz (fixed wave #150) to 5000 kHz (fixed wave #200). In the simulation, only the continuous frequency range is implemented.

The RSI-6M1 receiver and the RSI-6K transmitter are usually tuned to the same frequency. Since they have a common antenna, it is only possible to either receive or transmit a signal at any given time (in contrast with mobile phone operation). That is why this is a half-duplex (in the Russian terminology – simplex, according ITU-T) radio set.

The RSI-6K transmitter has two operation modes:

a) Normal mode. Anodes and lamp screen grids are supplied by normal voltages, according to GOST (soviet set of technical standards). Transmitting power is 6-8 W;

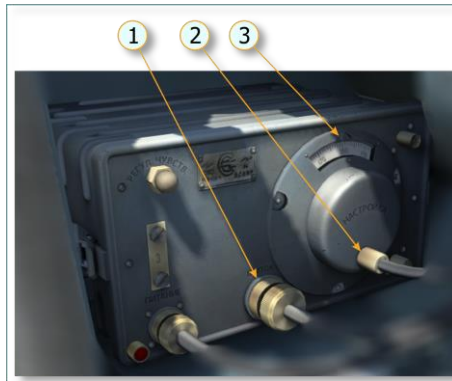
b) Forced mode with increased transmit power. Anodes and lamp screen grids are supplied by increased voltages, according to GOST. Transmitting power is 8-10 W; The implementation in the simulation allows the use of this mode with increased communication range. Increased transmit power mode can be enabled by setting the following switch on the right side of the cockpit in the up position.



Enabling this mode increases the probability of failure of the transmitter amplifier tubes. Therefore it is recommended to use this mode in emergency cases only.

### 6.1.2. RSI-6M1 receiver

The RSI-6M1 receiver (Figure 6.4) has the same range of fixed waves as the transmitter: from #150 to #200 (3.75 – 5.00 MHz).



1. Socket for remote control panel connection, see below.
2. Socket for flexible cable connection (from remote panel). Cable is used to rotate tuning disk.
3. Marker showing tuned wave number.

Figure 6.4. RSI-6M1 receiver front panel

The main characteristics of the RSI-6M1 receiver are listed in Table 6.1.

Table 6.1

Nº	Characteristic	Value
1.	RSI-6M1 receiver frequency range, MHz (includes fixed waves from #150 up to #200)	3.75-5.00
2.	Receiver sensitivity, uV	8-10
3.	Communication range, km:	
	altitude 500 m	80-90
	altitude 1000 m	120-130

Nº	Characteristic	Value
4.	Receiver supply voltage, V transformer (current converter) is not needed	24-29
5.	Power consumption, W	50
6.	Modulation	AM (amplitude)

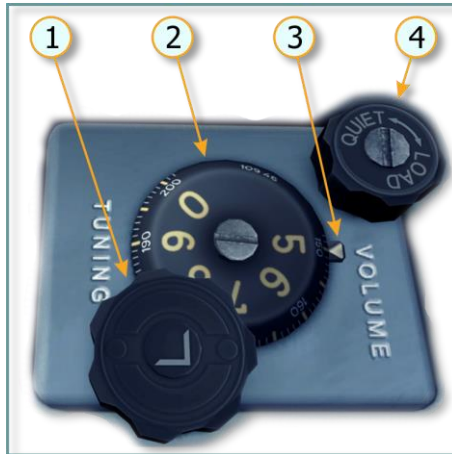
The receiver unit can only be controlled remotely, because it has no external control knobs or levers and only contains the wave number indicator (3), [Figure 6.4](#). It shows the wave number in accordance with the wave range classification of that time.

Frequencies and their corresponding wave numbers are listed in Table 6.2.

**Table 6.2**

Freq., kHz	Wave #	Freq., kHz	Wave #	Freq., kHz	Wave #
3750	150	4250	170	4750	190
3775	151	4275	171	4775	191
3800	152	4300	172	4800	192
3825	153	4325	173	4825	193
3850	154	4350	174	4850	194
3875	155	4375	175	4875	195
3900	156	4400	176	4900	196
3925	157	4425	177	4925	197
3950	158	4450	178	4950	198
3975	159	4475	179	4975	199
4000	160	4500	180	5000	200
4025	161	4525	181		
4050	162	4550	182		
4075	163	4575	183		
4100	164	4600	184		
4125	165	4625	185		
4150	166	4650	186		
4175	167	4675	187		
4200	168	4700	188		
4225	169	4725	189		

The receiver remote control panel (RCP) (Figure 6.5), located on the left side, has to be used for tuning. It is connected with the receiver unit by electrical cable and flexible cable (needed to rotate the tuning disk):



1. Channel selector knob
2. Channel disk
3. Fixed mark
4. Volume knob

**Figure 6.5. RSI-6M1 receiver remote control panel**

(1) *CHANNEL SELECTOR KNOB*. This knob, labeled НАСТРОЙКА (TUNING), is used to tune the receiver to the desired wave number (channel).

(2) *CHANNEL DISK*. This disk moves when the channel selector knob is operated and indicates the currently selected channel on the receiver. Number 5 corresponds to wave #150, 6 to #160 and 0 to #200.

(3) *FIXED MARK*. The current selected channel is indicated directly below this mark (arrow / inverted triangle).

(4) *VOLUME KNOB*. This knob, labeled ГРОМКОСТЬ (VOLUME) is used to set the receiver volume. Turning it clockwise in the ГРОМКО (LOUD) direction, increases the volume. Turning it counter-clockwise in the ТИХО (QUIET) direction, decreases the volume.

The pilot tunes the receiver by turning the knob (1) on the receiver remote control panel.

The RSI-6M1 receiver allows parallel connection of ARK-5 receiver output to hear NDB callsigns and broadcast transmissions simultaneously. Responsible for this connection is a PP-45 type АРК-ПРИЕМ (ARK-RECEIVE) switch, located on the left side.



When this switch is in the ADF position (and the ARK-5 is operating), signals from both the ARK-5 automatic direction finder and the RSI-6M1 receiver can be heard in the pilot's headset. This allows to simultaneously hear letters of NDB callsigns (or medium wave radio transmissions) and voice of shortwave channel user (traffic controller). When in the ПРИЕМ (RECEIVER) position, only the RSI-6M1 radio signal will be heard (traffic controller).

The receiver has noise suppression (during receive pauses) and automatic sensitivity control.

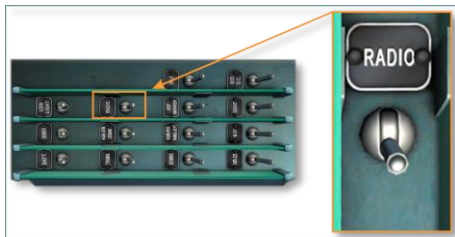
### 6.1.3. RSI-6 in game

In the simulation, the radio set is used to model radio communication with airfield ATC, between aircraft and with other virtual assets. Communication with mission assets is simulated in the form of formalized requests/orders. They can present player requests/orders: permission to land, take off, taxi, change formation, air group control commands with consequent formalized responses from assets. To perform formalized requests, it is necessary to tune the radio (transmitter and receiver) to a desired preset (normally listed in the briefing) frequency (ATC, wingman or various forces employed in mission), after that start formalized *RADIO COMMUNICATION*.

#### *RSI-6 transceiver tuning*

In the simulation, it is possible to simultaneously tune the RSI-6M1 receiver and the RSI-6K transmitter to the same frequency. This can be done by tuning the wave number (frequency) from the remote control panel (RCP). Rotation of channel/wave number selector knob (1) on the receiver RCP simultaneously rotates the knobs (2) and (5) [Figure 6.3](#) on transmitter.

1. Turn on the РАДИО (RADIO) switch (on the right side of the ACB panel):



2. Set the АРК-ПРИЕМ (ADF-RECEIVE) switch to the ПРИЕМ (RECEIVE) position to improve RSI-6M1 receiver listening quality on the selected channel.

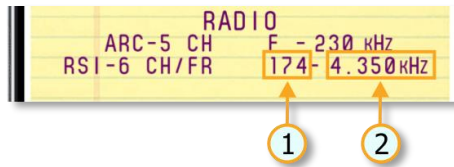


3. Tune RSI-6K to airfield ATC shortwave (SW) frequency. To do that:
  - a) Activate kneboard (**|K|**) for immediate indication – the kneboard is displayed as long as the button is held down – or **|RShift + K|** for toggle permanent kneboard display on and off) to monitor RSI-6 frequency:



- b) Set the desired frequency by rotating the knob ([Figure 6.5, 1](#)) on the RCP with the mouse wheel (**|LShift + turn of mouse wheel|**)

will increase rotation by a factor of 10), which corresponds to airfield ATC ([Table 6.2](#)). The wave number is displayed on the RCP's channel disk, below the fixed mark ([Figure 6.5](#), 3), or on the kneeboard:

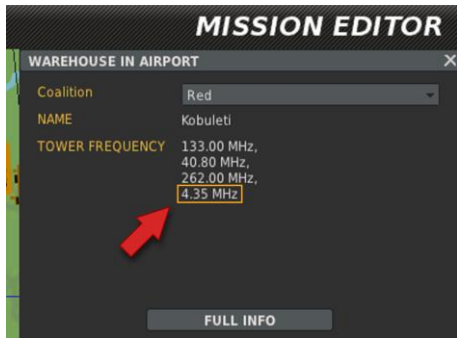


1. CH – Wave number (channel)

2. FR – Frequency

Note: Frequency, mentioned in briefing, MUST be set with  $\pm 5$  kHz precision.

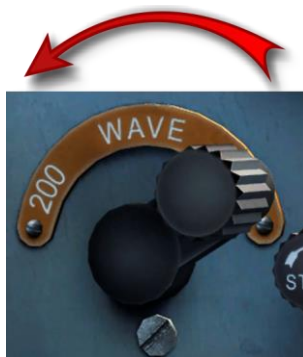
- c) The ATC's shortwave frequency, which is compatible with the RSI-6K frequency range of 3,75-5 MHz, can be found in the mission editor map by left-clicking on the desired airfield:



**Notes.** 1. For those who want to use the full range of options of the RSI-6K radio set, it is possible to tune the transmitter to ground station frequency (i.e. receiver is tuned to one frequency and transmitter to a different one). For separated tune of transmitter it is necessary to tune separately transmitting contour and antennas, using the following scales:



for transmitting contour



for antenna

In this case pilot kneeboard will contain two different frequencies one for receiver and another one for transmitter.

2. It is possible to control receiver tuning without kneeboard, simply by turning head back to the left and observing wave number on the RSI-6M1 unit ([Figure 6.4](#), 3).

3. It should be noted that if the player after setting the transmitter turned receiver wave knob, the transmitter immediately will be set to the current frequency of the receiver.

## 6.2. Radio communication

See the document "DCS World Radiocommunication\_EN.pdf".

## 6.3. Radio electronic equipment

There are several radio electronic devices on MiG-15bis which belong to the simplified instrument landing system:

- ARK-5 automatic direction finder.
- MRP-48P marker beacon receiver.
- RV-2 low altitude radar altimeter.

### 6.3.1. ARK-5 automatic direction finder

[Left side](#) of the cockpit, [right side](#) of the cockpit.

A list of all non-directional radio beacons in DCS World can be found inside the file "DCS World List of all available Beacons EN.pdf".

The automatic medium wave direction finder ARK-5 is designed to assist airplane navigation using non-directional beacons (NDBs), broadcast radio



stations and radio beacons and to determine the calculated airplane position. The ARK-5 solves the following navigation tasks:

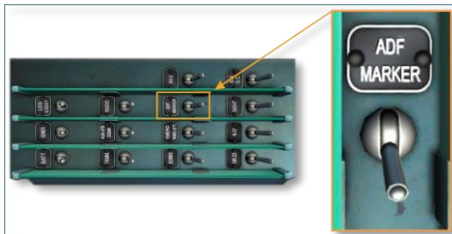
- flight to radio station/beacon with visual course indication;
- flight to radio station/beacon with audial course indication;
- flight from radio station/beacon (secondary/supplementary function);
- the drift angle and wind vectors estimation;
- automatic radio station/beacon bearing determination using compass gauge and manual audial bearing determination by rotating the antenna frame.

The ARK-5 allows automatic reception of radio station bearing, because its antenna frame with the help of an electrical motor automatically sets to a zero receiving position (received signal has the minimum value) pointing to a specific radio station, the frequency of which is set on the direction finder control panel. There are two frame positions relative to the ground radio station when the signal has "zero" value. To prevent that and to ensure that the frame is pointing to the radio station with a correct "front" edge, a special contour is installed, but it works in automatic mode only (КОМП position).

The frequency range of the automatic direction finder is continuous within 150-1300 kHz.

When used as an automatic direction finder, the ARK-5 has an operating distance of 160-200 km (with 500 W non-directional beacons).

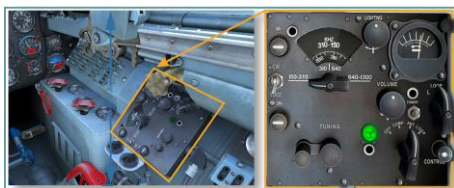
### ***Cockpit objects connected to ARK-5***



The APK MAPKEP (ARK MARKER) ACB, located on the right circuit breaker panel, connects ARK-5 and MA-250 inverter to the airplane's 27-29 V electrical network.



The SUP-7 gauge of the ARK-5 is located on the instrument panel and shows the selected NDB bearing.



The K-7 control panel turns on the ARK-5, selects its operating modes and tunes the frequency (see below).



The ПРИВОДНОЙ БЛИЖ-ДАЛЬН (NEAR-FAR NDB) switch selects one of two pre-tuned frequency ranges.



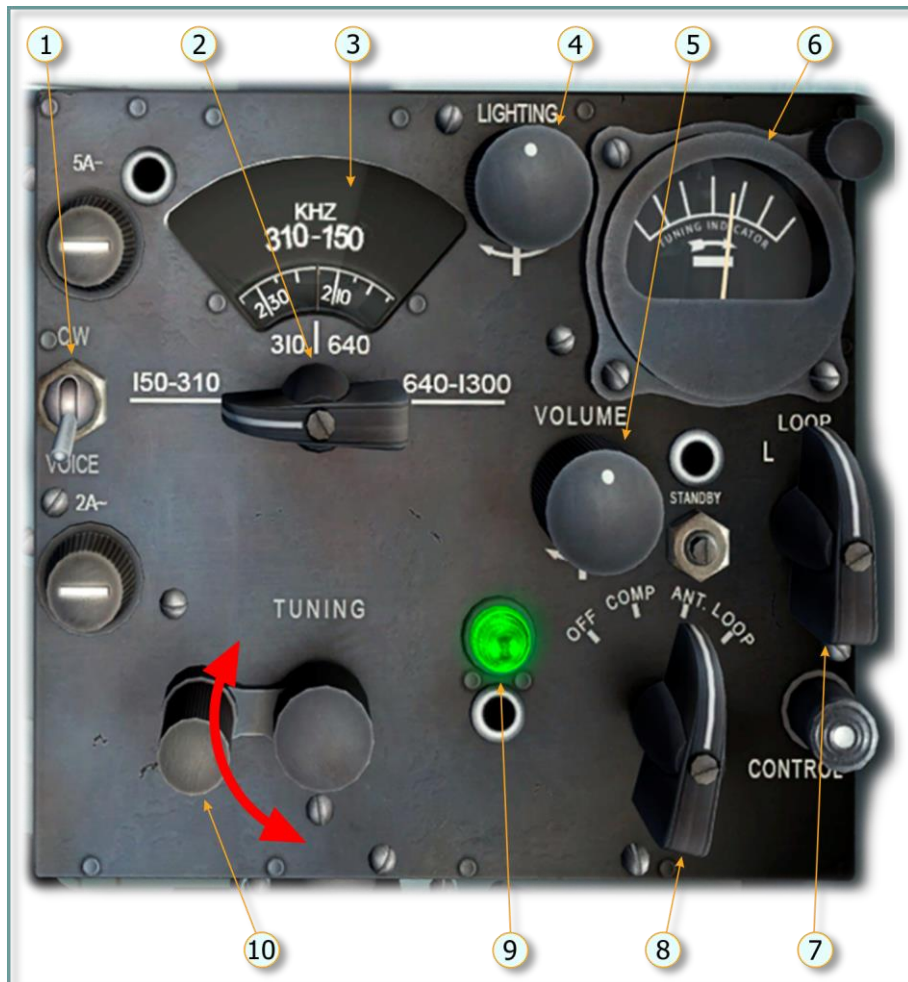
The near NDB frequency range control panel is used to select near NDB frequency ranges.



The АРК-ПРИЕМ (ARK-RECEIVE) switch, when in the ARK position, connects the ARK-5 output in parallel with the RSI-6K receiver output to the pilot's headphones.

### ***Direction finder control panel***

The K-7 control panel (Figure 6.6) is located on the right side of the cockpit.



**Figure 6.6. ARK-5 K-7 control panel**

- |   |                                       |
|---|---------------------------------------|
| 1. ТЛГ-ТЛФ (TLG-TLF) receiver mode switch               | 5. Volume knob                        |
| 2. Three-position ARK-5 frequency range selector switch | 6. Receiver tuning meter              |
| 3. Frequency range indicator with rotating scales       | 7. ПАМКА Л-П (L-R) spring return knob |
| 4. Backlight intensity control knob                     | 8. ARK-5 mode selector switch         |
|   | 9. ARK-5 on/off lamp                  |
|   | 10. Precise frequency tuning crank    |

(1) *ТЛГ-ТЛФ (TLG-TLF) RECEIVER MODE SWITCH*. This switch is used to select between two receiver modes: reception of modulated (ТЛФ – TLF for telephony) or non-modulated (ТЛГ – TLG for telegraph) signals. Usually, all radio stations work in phone mode (ТЛФ).

(2) *THREE-POSITION FREQUENCY RANGE SELECTOR SWITCH*. This switch is used to select one of the following three frequency ranges: 150–310 kHz, 310–640 kHz, 640–1300 kHz.

(3) *FREQUENCY RANGE INDICATOR* with three rotating scales:



(4) *BACKLIGHT INTENSITY CONTROL KNOB*. This knob, labeled ПОДСВЕТ (ILLUMINATION), sets the backlight intensity of the K-7 control panel.

(5) *VOLUME KNOB*. This knob, labeled ГРОМКОСТЬ (VOLUME), sets the desired volume level for listening to NDB callsigns.

(6) *RECEIVER TUNING METER*. The arrow shows current signal strength. It is necessary to achieve maximum level while tuning by rotating the corresponding knob.

(7) *ПАМКА Л-П (L-R) SPRING RETURN KNOB*. This knob, labeled ПАМКА (LOOP), is used for manual antenna rotation from zero receive position.



It is a spring-loaded rotary switch, i.e. to hold it in the L or R positions, it is necessary to keep the hand on the handle. When released, this switch automatically returns to its initial (centered) position.

Can be used to verify КОМП (direction finder) mode and for manual NDB bearing searching (see below). Antenna frame and indicator arrow deflects using this spring return knob in ПАМКА mode only. To deflect, it is necessary to rotate the knob to the desired position and keep it. In the Л (L – LEFT) position, the frame is deflected to the left. In the П (P – RIGHT) position, it is deflected to the right.

*(8) ARK-5 MODE SELECTOR SWITCH.*



This switch sets the different operating modes of the ARK-5 and has the following positions (from left to right):

- ВЫКЛ. (OFF) – turns off ARK-5;
- КОМП. (COMP.) – direction finder, turns on ARK-5 in automatic mode;
- АНТ. (ANT.) – antenna, enables hearing of NDB callsigns (non-directional antenna works only). In this mode, callsigns are heard more clearly than in КОМП. mode.
- ПАМКА (LOOP) – to manually rotate the antenna frame in zero signal position angle.

*(9) ARK-5 ON/OFF LAMP.* Illuminates when the ARK-5 is on, i.e. in any other position than ВЫКЛ (OFF).

*(10) PRECISE FREQUENCY TUNING CRANK.* This tuning crank, labeled НАСТРОЙКА (TUNING), is used for precise manual frequency tuning with the help of the receiver tuning meter (6). Use the tuning crank to achieve maximum signal strength level.

### ***ARK-5 direction finder turning on and tuning procedure***

In the simulation, it is possible to manually tune the ARK-5 to a radio station with the help of the K-7 control panel and three pre-set frequencies from the mission editor.

For manual tuning to a radio station from the cockpit, the following steps are necessary:

1. Provide 27-29 V power supply to the aircraft's electrical network (turn on either the accumulator or ground power or start the aircraft and switch on the generator at an engine RPM of at least 4.000).
2. Switch on the АРК МАРКЕР (ARK MARKER) ACB.



3. Turn on the direction finder in non-directional antenna mode by rotating the ARK-5 mode selector switch ([Figure 6.6](#), 8) to the АНТ. (АНТ.) position. Wait 1-2 minutes while the vacuum radio tubes are warming up.
4. Set the ТЛГ-ТЛФ (TLG-TLF) receiver mode switch to the position which corresponds to the NDB operation mode (ТЛФ or ТЛГ). Normally, all NDBs in DCS World operate in phone (ТЛФ) mode.
5. Set the volume knob (5) in the rightmost position.



6. Set the АРК-ПРИЕМ (ARK-RECEIVE) switch to the АРК (ARK) position.



7. Set the ПРИВОДНОЙ БЛИЖ ДАЛЬН (NEAR-FAR NDB) switch to the ДАЛЬН. (FAR) position.



8. Select the desired frequency range using the three-position ARK-5 frequency range selector switch ([Figure 6.6](#), 2, 3).
9. Use the precise frequency tuning crank (10) to rotate the frequency scale until the desired frequency is indicated over the vertical (relative to scale) pointer.



Achieve stable reception (by listening) of NDBs callsigns and maximum arrow deflection on the precise tuning meter (6).



To rotate the precise frequency tuning knob with the mouse, place the mouse cursor over its center (knob rotation axis).

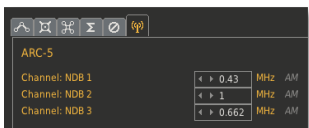
10. Select automatic direction finder mode by setting the ARK-5 mode selector switch (8) to the КОМП. (COMP.) position. After that, the arrow on the SUP-7 gauge will show NDB bearing.



11. To check setup quality, switch to PAMKA (LOOP) mode and rotate the spring-loaded PAMKA Л-П (L-R) knob in any direction and keep it in this position for several seconds. The arrow on the SUP-7 will deflect at a certain angle. Release the knob and return into КОМП. (COMP.) mode. The arrow should return to its initial position.

**To set up three frequencies from mission editor, perform the following steps:**

1. Open the ARK-5 frequencies tab in the mission editor, set the required frequency (in MHz) for each of the three channels and save the mission.



The channel numbers correspond to the switches on the near NDB frequency range control panel (top-down).

2. After starting the simulation, perform steps 1-6 as for manual setup.
3. Set the ПРИВОДНОЙ БЛИЖ ДАЛЬН (NEAR-FAR NDB) switch to the БЛИЖ (NEAR) position.



4. On the near NDB frequency range control panel, switch on the necessary switch (to the right). Channels are numbered top-down. After switching on one of the above switches, receiver re-tunes to the frequency preset in ME for this channel.



For switching frequency ranges, an electrical motor is installed in the ARK-5 unit. It is controlled by rotating the frequency range selector switch (Figure 6.6, 2), when the ПРИВОДНОЙ БЛИЖ – ДАЛЬН (NEAR-FAR NDB) switch is set to ДАЛЬН (FAR) position. If this switch is set to the БЛИЖ (NEAR) position, then the electrical motor control circuit is controlled by switches 1-3 on the near NDB frequency range control panel and not by the selector switch.

Thus, when one of these switches is enabled, the pre-defined (in mission editor) frequency range will be automatically selected by the electrical motor independently of selector switch position. The ARK-5 receiving contour starts working on the frequency which was specified for this channel in the mission editor and the indicator will indicate the current operating frequency range (Figure 6.6, 3).

**Warning:** Switching on more than one frequency range is forbidden, due to high risk of malfunction of the electrical motor, which is controlling the connection of frequency ranges.



5. Select direction finder mode by setting the ARK-5 mode selector switch to the КОМП. (COMP.) position. As a result, the arrow on the SUP-7 gauge will indicate NDB bearing.



### ***Power supply and ARK-5 operation***

The direction finder is supplied by alternate current from the MA-250 inverter (115 V 400 Hz).

Powering of the ARK-5 control panel and MA-250 by direct current (27-29 V) is performed from the aircraft's electrical network via an automatic switch, installed on the right electrical panel.

One must remember that the medium wave ARK-5 is affected by mountain and night effects, which can lead to  $\pm 15^\circ$  errors in NDB bearing determination.

### **6.3.2. MRP-48P marker beacon receiver**

The MRP-48P marker beacon receiver is designed for receiving ultra-short wave marker beacon signals and is used to determine the moment when the aircraft is flying over a beacon. This moment is indicated by the illumination of a warning lamp, installed on the instrument panel, and a buzzer sound.

The MRP-48P operation principle is based on reception and conversion of high frequency pulses, transmitted by a marker beacon, into direct current pulses with the same duration, which illuminate the warning lamp and turn on the electrical buzzer.

The marker beacon signal is the 75 MHz carrier frequency, modulated by audible frequencies of 400, 1300 or 3000 Hz, depending on the distance from the runway. It emits signals with its antenna pointed vertically, with the space angle around  $20^\circ$ . This angle depends on receiver sensitivity setup (the MRP-48P has no such feature). Besides that, to find out which marker was flown-over by an aircraft, aural frequencies change (Morse code is used). In DCS World, the pulse repetition rate for a near marker beacon is higher than for a far NDB, but it is impossible to hear these signals using the MRP-48P (no such feature) and buzzer buzzes with constant frequency.

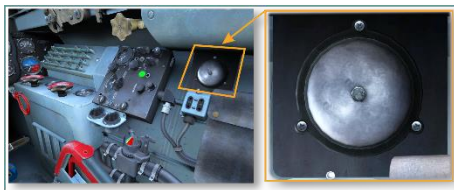
The MRP-48P equipment set consists of:

- receiver;

- antenna inside the fuselage;
- MAPKEP (MARKER) signal lamp on the instrument panel;



- buzzer on the right cockpit side;



The receiver is installed in the tail part of the fuselage on the back kerosene tank hatch.

The main MRP-48P characteristics are listed in Table 6.3.

**Table 6.3**

<b>№</b>	<b>Characteristic</b>	<b>Value</b>
1.	Operating carrier frequency (MHz)	75
2.	Triggering height (beacon overflight), m	Not less than 2000
3.	Low frequency receiver tune frequency (Hz)	3000

### ***MRP-48P enabling***

Both receiver and buzzer are supplied by low voltage from the aircraft's electrical network via the APK MAPKEP (ARK MARKER) ACB installed on the right electrical panel. No other settings are required.



### 6.3.3. RV-2 radar altimeter

The low altitude radio altimeter of RV-2 "Кристалл" ("Crystal") type was developed to determine actual flight altitude over the earth surface within 0-1200 m. After being enabled, the radar altimeter operates automatically.

The RV-2 equipment set consists of:

1. Transceiver.
2. [PRV-46](#) altitude gauge.
3. RU-11AM unformer (for converting 27-29 V direct current into 220 V direct current and supplying radar altimeter tubes anodes).
4. Transmitting and receiving antennas. The receiving antenna is installed on the right wing lower surface. The transmitting antenna is installed on the left wing lower surface.
5. Connecting cables.

Radio altimeter operation is based on the reflection of radio waves from the earth surface with the use of frequency modulation. The radio altimeter transmitter transmits a modulated carrier frequency towards the earth surface. These waves reflect from earth surface and return into the receiver (reflected signal). Simultaneously, the receiver input is fed by a signal taken directly from the transmitter (reference signal). Due to the fact that the reflected signal path, which depends on flight altitude, significantly exceeds the reference signal path, the reflected signal gets into the receiver with some delay and beat frequency appears. This frequency is amplified and transforms into direct current which deflects the PRV-46 gauge arrow.

The radar altimeter is supplied from the aircraft's direct current electrical network with 27-29 V via the PB-2 (RV-2) automatic circuit breaker located on the right electrical panel. RV-2 characteristics are listed in Table 6.4.

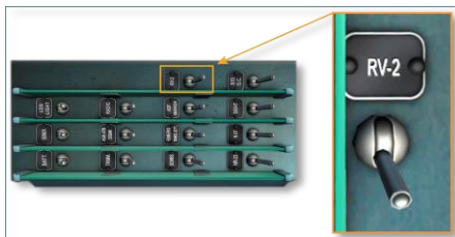
**Table 6.4**

<b>№</b>	<b>Characteristic</b>	<b>Value</b>
1.	Measured height range:	
	I range (low altitudes)	0–120 m
	II range (high altitudes)	100–1200 m
2.	Altitude measurement error (from measured altitude):	
	I range	±2 m ±5%
	II range	±20 m ±5%
3.	Sensitivity slack:	
	I range	240 m
	II range	2000 m
4.	Median transmitter frequency	444 ±2 MHz (68 cm wave)
5.	Modulation frequency	124 ±3 Hz
6.	Transmitting power	Not less than 0,15 W
7.	Power supply	electrical network 26,5±10%V direct current
8.	Consumed power	not more than 70 W

### ***Enabling and setting up radar altimeter***

To enable the RV-2, perform the following steps:

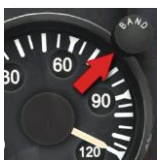
1. Turn on the PB-2 (RV-2) ACB on the right electrical panel:



2. Enable the gauge by rotating the knob clockwise to the ВКЛ (ON) position.



Select the desired altitude measurement range (0–120 m or 100–1200 m) with the ДИАПАЗОН (ALTITUDE RANGE, BAND) knob on the [PRV-46](#) gauge (top right):



3. Altimeter is ready to use. If necessary, the pilot can change the altitude measurement range in flight without turning off the device.



# 7

## FLIGHT AND RELATED PROCEDURES

## 7. FLIGHT AND RELATED PROCEDURES

The main procedures, from aircraft preparation to the engine shutdown procedure after taxiing to a parking spot, are described below. Optional procedures are marked with an asterisk (\*).

### 7.1. Start, engine testing, aircraft systems control, taxiing to runway

#### 7.1.1. Cockpit equipment check

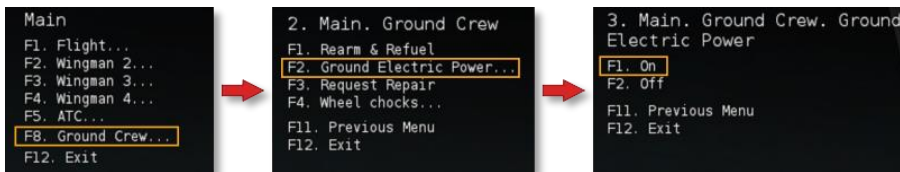
1. Before engine start, check positions of ACBs and various switches on the right ACB panel:

- a) Battery switch, labeled АККУМУЛЯТОР (ACCUMULATOR), should be OFF [LAlt + LCtrl + Z].
- b) ГЕНЕРАТОР (GENERATOR) switch should be ON [LAlt + LCtrl + A].



2. Connect external ground power supply:

| \ | (radio menu), | F8 |, | F2 |, | F1 | (request ground power).



Check ground power supply using the landing gear signal lamps (Figure 3.12, 4, they should illuminate green) and the combined volt-/ammeter. Voltage should be at least 24 V (push the button under the scale so that the device indicates voltages).



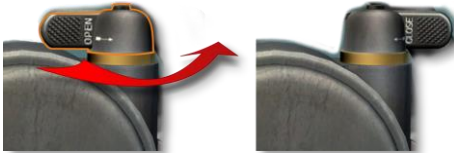
3. Enable all switches, which are necessary for flight, on the right ACB panel, except the accumulator/battery switch and weapon related switches.



4.\* Check trimmers, [radio](#), [radar altimeter](#) and [ADF](#) operation.

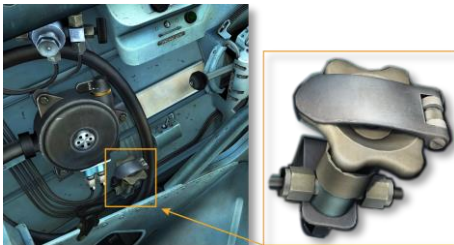
### 7.1.2. \* Oxygen supply system check

Open the oxygen supply by setting the diluter valve handle of the KP-14 oxygen regulator in the OTKP (OPEN) position:

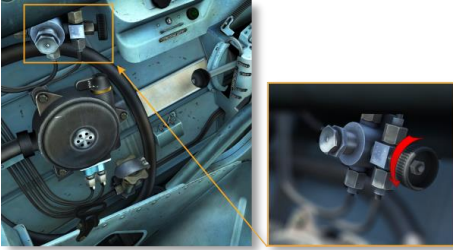


**Note** : The simulation assumes the pilot is always wearing the oxygen mask. Failure to open the diluter valve means the pilot will be starved of oxygen and may begin to **lose consciousness** in 30 - 40 seconds.

2. Open the oxygen supply valve by rotating it counter-clockwise/to the left:



3. Check the emergency oxygen supply by completely opening the emergency oxygen supply valve:



The IK-14 flow indicator shows immediate oxygen consumption – the indicator segments diverge upwards and downwards and do not converge, indicating continuous oxygen flow to the mask.



4. Close the emergency oxygen supply valve. The system is ready for operation.

After reaching an altitude of more than 2000 m, when adding oxygen to the air mixture begins, the indicator segments will diverge and converge with the breathing frequency.

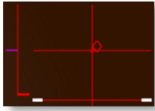
Preflight status of the equipment:

- oxygen supply valve – opened;
- diluter valve – OTKP (OPEN).  
Note that in the OPEN position, the diluter valve handle points to the right, the label for the 3AKP (CLOSE) position is visible on the handle and the OTKP (OPEN) label is hidden on the back of the handle.

### 7.1.3. Preparing equipment for startup

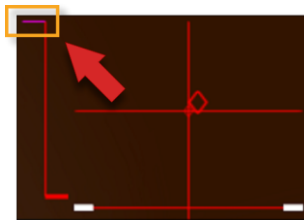
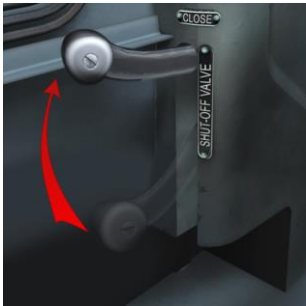
**Note:** In the simulation, the controls indicator can be displayed [|RCtrl + Enter|](#) to verify the position of the fuel shut-off valve.





By looking at this indicator and alternately pressing **|RShift + Home|** and **|RShift + End|** the player can get a feel for the opening/closing speed of the valve.

1. Verify that the shut-off valve is closed (lever is in the up position) by pressing **|End|**. [Return to Main flight controls diagram](#)



Sequentially enable the following ACBs on the left electrical panel:

2. Switch on the ПРИБОРЫ КОНТРОЛЯ ДВИГАТЕЛЯ (ENGINE MONITORING GAUGES) ACB **|LAlt + LCtrl + 3|**. The following two red lamps will light up:

- Generator off warning lamp, labeled ГЕНЕРАТОР ВЫКЛЮЧЕН (GENERATOR OFF)
- Engine start prohibited lamp, labeled ЛАМПА ГОРИТ НЕ ЗАПУСКАЙ (DO NOT START ENGINE IF LIGHT IS ON)

The fuel gauge will show 1050 liters, the fuel and oil pressure gauges' arrows will point to zero on their corresponding scales and the oil thermometer arrow will show the temperature in the oil pumps box.

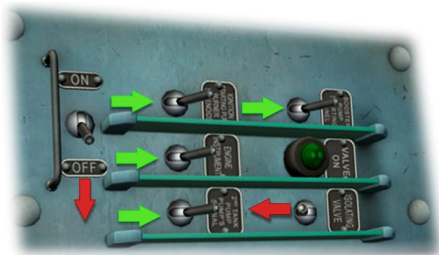
3. Switch on the ЗАЖИГАНИЕ (IGNITION), ПУСКОВАЯ ПОМПА (STARTING PUMP), СОЛЕНОИДЫ ФОРСУНОК (INJECTOR/NOZZLE SOLENOIDS) switch **|LAlt + LCtrl + 2|**.

4. Enable the БУСТЕР-ПОМПА (BOOSTER PUMP), ПУСКОВАЯ ПАНЕЛЬ (START PANEL) switch **|LAlt + LCtrl + 1|**. The red engine start prohibited lamp,

labeled ЛАМПА ГОРИТ НЕ ЗАПУСКАЙ (DO NOT START ENGINE IF LIGHT IS ON), will go out, indicating normal operation of the fuel pump.

5. Enable the ПОМПА 2-ГО БАКА (SECOND TANK PUMP) switch [[LAlt + LCtrl + 4](#)]. In case of normal pump operation and if there is some fuel in the tank, the green second fuel tank empty warning lamp, labeled 2-Й БАК (SECOND TANK), will illuminate and then go out after a few moments.

The following image shows the positions of the ACBs on the left electrical panel before engine startup:



#### 7.1.4. Engine startup

1. Set the throttle lever in the full-back position (pull the lever back towards the pilot) [[Num-](#)]. The engine will not start in any other position!



2. Open the cover of the engine start button on the throttle lever [[RAlt + Home](#)]. Press the engine start button for 1-2 seconds [[RCtrl + Home](#)]. If the button is pressed for less than 1 second, the engine will not start!



The beginning of the startup process is determined by tachometer arrow deflection and a constantly increasing tone in the compressor sound.

3. When the engine rotor reaches 600 RPM, open the fuel shut-off valve to the medium position by pressing [|Home|](#) (or by using the mouse wheel to approximately set the valve to the middle position).



When the RPM reach 900-1200, open the shut-off valve completely [|RShift + Home|](#) (keep it pressed) with a smooth 1.5 – 2 second movement. Keep monitoring the temperature, which should not exceed 650 °C.



Note. Opening the valve from the middle "50%" position to the "full open" position (by holding [RShift](#) + [Home](#)) takes about 3 seconds.

With the throttle lever in the full-back position, the engine reaches idle mode automatically. In this mode, engine RPM should be within 2400-2600, exhaust gas temperature should not exceed 510°C, oil pressure should not be less than 0.2 kg/cm<sup>2</sup>, and fuel pressure should stay within 7-12 kg/cm<sup>2</sup>.



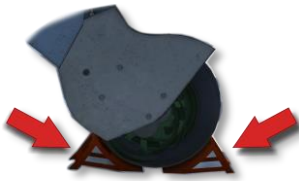
4. Immediately after successful engine startup and reaching the idle mode, smoothly increase engine revolutions to 4000-4500. Check correct generator operation, i.e. that the red generator off warning lamp, labeled ГЕНЕРАТОР ВЫКЛЮЧЕН (GENERATOR OFF), is off.

5. Give the order "Turn off ground power" to the ground crew and turn on the battery/accumulator [LAlt + LCtrl + Z].

| (radio menu), [F8], [F2], [F2] (turn off ground power).

6. Increase engine RPM to 6000-7000 (to warm up the engine) and after that start testing engine operation\*.

Note. Because an engine RPM setting above 5500 may move the aircraft from a standstill, performing an engine run-up check at power settings above 5500 requires the application of wheel brakes or placement of wheel chocks:



To request placement of wheel chocks, contact the ground crew as follows:

| (radio menu), [F8], [F4], [F1] (request placement of wheel chocks).

### 7.1.5. Pilot actions in case of unsuccessful engine start

1. If, during the engine startup procedure, the exhaust gas temperature exceeds 650°C and the start panel operation cycle is not finished, the startup procedure has to be interrupted. For that it is necessary to switch off the БУСТЕР-ПОМПА, ПУСКОВАЯ ПАНЕЛЬ (BOOSTER PUMP, START PANEL) ACB and close the engine shut-off valve.

If the start panel operation cycle is finished, the startup procedure has to be interrupted by closing the shut-off valve only.

2. If during engine startup unstable engine operation is noticed, which can be accompanied by a humming noise (rumbling) and an increase of exhaust gas temperature, it is necessary to close the shut-off valve a little bit [RShift + End] (engine RPMs should not drop drastically), wait for 1-2 seconds, and smoothly open the shut-off valve completely [RShift + Home]. The startup cycle normally takes 35-40 seconds.

### 7.1.6. \* Engine operation check

1. Set the engine RPM to 6500-7500 and check operation of the isolating valve. Enable the ИЗОЛИР КЛАПАН (ISOLATING VALVE) ACB



[LAlt + LCtrl + 5].

The green signal lamp connected to the isolating valve should illuminate, engine revolutions can drop by 250 (RPM increase is not limited), exhaust gas temperature can change by 10-15°. Constant RPM and their reduction of more than 250 indicates fuel automatic malfunction.

Note: At a temperature of +20°C and a pressure of 760 mmHg, the revolutions should not change for more than one minimal scale interval.

2. Turn off the isolating valve. Engine RPM should return to their initial value.
3. Check the ART-8B throttle response automat:
  - a) Set the wheel chocks under the main landing gear: [N] (radio menu), [F8], [F4], [F1] (set wheel chocks);
  - b) Move the throttle lever from the 5000 RPM position to the far most position within 1.5-2 seconds. It should take around 11-14 seconds for the engine to increase revolutions from 5000 RPM to the maximum value. The momentary increase of exhaust gases should not exceed 770°C, revolutions – 11800 RPM.

Engine gauges/instruments should have the following parameters:

- revolutions 11560 <sup>+40</sup>·<sub>-100</sub> RPM;
- exhaust gases temperature – not more than 690°C;
- fuel pressure before injectors – 45±4 kg/cm<sup>2</sup>;
- oil pressure – 1.4-3.5 kg/cm<sup>2</sup>;
- oil temperature from -40 and up to +90°C.

4. At maximum RPM, turn on the isolating valve. Engine RPM can decrease by 200, stay the same, or increase by 50.

5. Move the throttle lever to the full-back position and check engine operation in the idle mode. Engine revolutions should be 2500 +100 RPM, exhaust gases temperature not more than 510°C, fuel pressure 7-12 kg/cm<sup>2</sup>, oil pressure not less than 0.2 kg/cm<sup>2</sup>.

Note : Idle mode RPM and temperature values in flight can differ drastically from the ones monitored on the ground, depending on flight speed and altitude (the higher the altitude, the higher the idle RPM). The reason for this is the regulation law of the barometric regulator, which is installed in the fuel engine automatics.

### 7.1.7. \* Hydraulic system check

1. Set RPM to 8000 and check hydraulic system. The hydraulic system pressure gauge in case of neutral valves position should indicate a pressure between 80-140 kg/cm<sup>2</sup>.



2. Move the flaps lever from the НЕЙТР (NEUTRAL) position to the takeoff position – Вып. 20° (EXTEND 20°) [LShift + F]. Control extension of the flaps using the mechanical pointer on the left wing through the cutout in the wing fence.



Hold the flaps lever in the Вып. 20° (EXTEND 20°) position for 1-2 seconds (this time is needed to trigger the hydraulic devices) and then move the lever

further to ВЫП. 55° (EXTEND 55°) |LShift + F| (all the way down).



The green 55° flaps extension angle signal lamp, indicating full flaps extension, will illuminate and the mechanical pointer on the left wing surface will extend completely.



**IMPORTANT!** When trying to extend the flaps straight away to 55°, without remaining in the ВЫП. 20° (EXTEND 20°) position for a while, the flaps retraction lock does not have enough time to open itself and the flaps cannot be extended.

3. Move the flaps lever all the way up to the ПОДЪЕМ (UP) position |LCtrl + F| 3x, without stopping at the takeoff and neutral positions.



The signal lamp will go out and the mechanical pointer will be retracted. After that, set the lever to the НЕЙТР (NEUTRAL) position |LShift + F|.

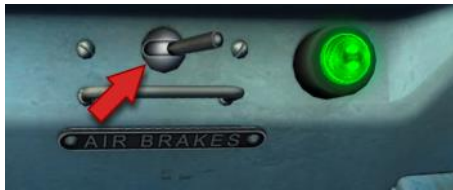
4. Check air brake operation by ...



- a) ... pressing the speedbrake extension button **|B|** on the control stick and monitoring the extension of air brakes;



- b) ... setting the ТОРМОЗНЫЕ ЦИТКИ (AIR BRAKES) switch on the left side of the cockpit to the Открыто (OPEN) position **|LShift + B|** and controlling the extension of the air brakes using the Тормозные щитки выпущены (AIR BRAKES EXTENDED) signal lamp. The lamp illuminates when the air brakes are extended at any angle.



- c)

### 7.1.8. Pilot actions before taxiing

1. When ensured that engine, brakes and other systems are operating properly and all needed ACBs are enabled, perform the following actions:

- a) Close canopy **|LCtrl + C|**



- b)
- c) Open oxygen supply valve by rotating it counter-clockwise/to the left **|LShift + O|**



- d)
- e) Pressurize cockpit |RShift + A|



- f)
- g) Remove wheel chocks (if they were used)
- h) |N| (radio menu), |F8|, |F4|, |F2| (remove wheel chocks)
- i) Request permission to taxi
- j) |N| (radio menu), |F5|, select the appropriate command.

## 2. Prepare for landing gear retraction:

Unlock the landing gear lever by pushing the latch to the left |LAlt + G|.



## 3. Extend flaps to 20°.

4. Ensure that taxiway is free, check brakes by firmly pushing the wheel brake lever |LShift + W|, increase engine revolutions to 10000 RPM – the aircraft should be held by the brakes.

Note : When pressing the wheel brake lever with regular force |W|, the brakes hold the aircraft for up to 8000 RPM.

## 5. Reduce RPM to 4000, look around and start taxiing:

- a) Increase engine RPM to 6000 (approximately);
- b) Release brake lever;

- c) After beginning to roll, keep a safe taxiing speed by increasing/decreasing RPM. The recommended speed is not more than 15 km/h.

Turns during taxiing have to be performed by deflecting the pedals **|Z|**, **|X|** (at least 50% of pedal operating range) and simultaneously using the brake **|W|**. A turn can be stopped by shortly pushing the pedal opposite to the turn and using the wheel brake.

## **7.2. Takeoff and climb**

1. After taxiing to the runway, it is necessary to roll the airplane in a straight line to align the nose wheel with the takeoff line. Align the course system, check the correctness of AI and direction finder readings.

Receive permission to take off from ATC and increase engine RPM to 8000-9000. Keeping the stick in the neutral position, release the brakes and increase engine RPM to takeoff value. Direction should to be maintained using brakes at the beginning of the roll and then by rudder as speed increases.

The rudder becomes efficient ("rudder authority") at a speed of 50-80 km/h.

2. When the speed reaches 150-160 km/h, lift the nose wheel from the ground by smoothly pulling the stick back (1/4 to 1/3 of maximum stick deflection). The aircraft's nose should be lifted in such a way that the horizon line and canopy are aligned as shown in [Figure 7.1](#), point 2. Keep the airplane in this position until takeoff.

3. At a speed of 220-240 km/h, the airplane smoothly detaches from the ground (with drop tanks this speed is 30 km/h higher).

Keep the airplane in this position while climbing.

4. At an altitude of 10-15 m and a speed of 350-400 km/h, retract the landing gear (it takes 6-8 seconds). Check successful retraction with the help of signal lamps (they should illuminate red), mechanical pointers (retracted) and pressure in the hydraulic system (has to be between 120-140 kg/cm<sup>2</sup>). Set the landing gear lever into the neutral position. The latch should be kept opened, [Figure 7.1](#), point 4.

5. Set an IAS of 500 km/h and a vertical speed of 7-8 m/s, simultaneously reducing engine RPM. Nose position relative to the horizon during climb is shown in [Figure 7.1](#), point 5.

When taking off with flaps extended, they have to be retracted at an altitude of 100 m. After retraction, the flaps lever should be set into the НЕЙТР (NEUTRAL) position. Continue climbing with the IAS and vertical speed values mentioned above. While retracting the flaps, the aircraft changes its balance (diving moment increases), which has to be compensated with small stick deflection.

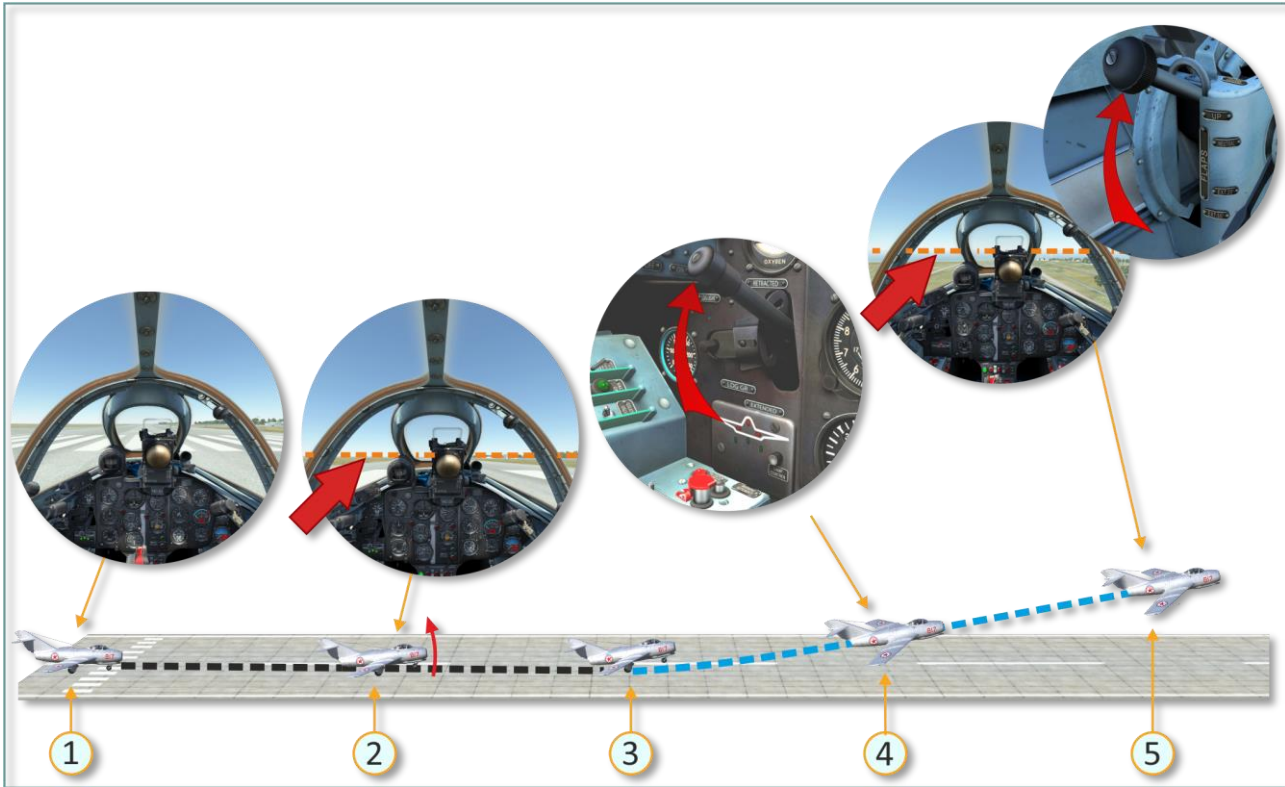


Figure 7.1. Takeoff procedure (orange dash line shows position of the horizon)

### **7.2.1. Forces and moments affecting airplane during takeoff and climb**

#### ***Takeoff roll***

Friction forces, engine thrust as well as pitching and diving moments applied to the aircraft affect both character and length of the takeoff roll.

- a) The friction force is directed against the movement of the aircraft: its value depends on the response of the ground surface, runway condition and aircraft weight.

At the beginning of the roll, the friction force is at its maximum. As speed increases, the friction force decreases.

To reduce the distance needed for the takeoff roll, extend flaps to 20°.

- b) During rolling, the engine thrust exceeds forces of resistance and creates acceleration. With the reduction of friction forces, the excessive thrust force increases.

To reduce the takeoff distance, the engine should operate at the highest RPM allowed (takeoff mode).

- c) During the second part of the takeoff roll, the pilot creates a pitching moment by deflecting the elevators upwards and thus lifting the nose gear up. With the increase of speed, due to increasing elevator efficiency, the pitching moment increases as well.

To prevent the airplane from taking off at low speed, the pilot has to "return" the stick slightly forward. Joystick movement should be very moderate, around 1 cm.

#### ***Lift-off and acceleration***

- a) The airplane lifts off at 220-230 km/h due to the difference between the lift force and the airplane weight.
- b) To achieve the airspeed needed for the climb, it is necessary to maintain a certain pitch (relative to the horizon). This acceleration stage should be performed with a gradual increase of altitude.

With the increase of airspeed, at a constant pitch, the lift available on the wings increases and drag slightly decreases (this is a manifestation of the general laws of aerodynamics and observed up to the so-called "economic" speed, see below). Therefore, the difference between thrust and drag increases and speed increases faster.

The pilot has to retract the landing gear at a certain speed to prevent it from being damaged by excessive aerodynamic forces.

### ***Climb***

Climb is characterized by the vertical and translational speeds chosen by the pilot. The needed translational speed is gained during the acceleration stage. The climb may differ based on the task:

- a) For flying in circles, the pilot has to reach and maintain 500 km/h IAS and a climb rate of 7-8 m/s.
- b) To intercept an aerial target and to reach the required altitude faster, it is necessary to achieve 710 km/h TAS (true airspeed) in a short period of time. This speed is called "economic" speed, because it ensures the maximum climb rate up to the ceiling. If 710 km/h TAS is not maintained, the climb rate will be lower. The vertical speed achieved with the engine operating on maximum RPM and 710 km/h TAS is about 45-35 m/s up to 5000 m.

The climb mode is set after the retraction of gear and flaps. Engine RPM has to be set to the required value with the throttle handle and correct pitch has to be set and maintained with the stick.

## **7.2.2. Correction of deviations during takeoff**

### ***1. Difficulties with maintaining direction during beginning of takeoff roll***

Reasons:

- Nose wheel is not aligned with takeoff line, because the pilot did not roll the airplane 5-10 m in a straight line after entering the runway.
- Wrong use of wheel brakes for maintaining takeoff direction (brake lever is kept pressed longer than needed).

To fix this, it is necessary to:

- stop further increase of engine RPM;
- align the airplane parallel to the runway by using brakes (short presses) and pedals, then release brakes and pedals to neutral positions;
- ensure that the airplane rolls in a straight line, increase RPM to the takeoff level and continue taking off;
- with the increase of the airplane's translational velocity, maintain takeoff direction with pedals only, without using the brakes.

## ***2. Nose gear lifts off at less than required speed***

Reasons:

- non-rational attention distribution while reaching 160 km/h ground speed and excessive pull of the stick trying to lift off nose gear;
- unsatisfactory control of visible airplane's parts relative to the horizon line while lifting the nose gear.

To fix this, it is necessary to:

- set visible parts of canopy according to [Figure 7.1](#), stage 2 (nose gear lift-off) by very smooth and small-amplitude stick movements and continue acceleration to the required speed;
- leave a small wiggling of the aircraft uncorrected, because correcting can lead to increased wiggling amplitude and to a stall on the wing;
- counter large amplitude movements by coordinated stick and pedal deflections to the opposite side.

## ***7.3. Approach and landing***

### **7.3.1. Approach**

1. Before approach set 400-450 km/h IAS.
2. At 400-450 km/h increase engine RPM (approximately 7000-8000 in horizontal level flight) and extend gears (extension time is about 8-10 seconds). Ensure that extension was successful by checking signal lamps, mechanical pointer and monitoring pressure in hydraulic system (has to be 120-140 kg/cm<sup>2</sup>).
3. On the glide path decrease speed to 320-350 km/h IAS, depending on airplane weight.



4. Set engine RPM to approximately 9000 and extend flaps – first to 20° and after 1-2 seconds to 55°. Set glide pitch, which corresponds to 320-350 km/h IAS, depending on weight, and gradually decrease speed to 260-270 km/h.

5. At an altitude of 200 m, the pre-landing gliding phase starts. Estimate landing conditions: direction, gliding angle (the point, towards which the airplane is gliding, has to be a bit before the runway threshold, or the beginning of the runway at the latest), roll, sideslip (in case of crosswind presence).

Note 1 (variant 1): In case of crosswind up to 10-12 m/s, the drift of the aircraft can be compensated with roll up to 10°. With higher wind velocities, the drift has to be compensated with both course (sliding) and roll. This landing technique is known as sideslip.

Note 2 (variant 2): In case of crosswind, the drift of the aircraft has to be compensated with course. This landing technique has several variations, depending on where the pilot aligns the airplane with the runway centerline. They are known as crab and de-crab.

With a speed of 260-270 km/h (engine RPM at least 6000, descent rate of 7-8 m/s), glide to the beginning of the landing flare.

6. At an altitude of 6-7 m, slightly pull back the stick to start decreasing the descent rate in such a way that the aircraft stops descending at an altitude of not more than 1 m. During the flare, decrease engine RPM to the minimum and maintain constant pitch and roll.

7. During the flare, speed gradually decreases to 180-200 km/h. As the speed decreases, the pilot increases pitch by pulling the stick towards him and thus deflecting the elevators upwards to keep the lift force counteracting the aircraft's weight constant. The airplane gradually and smoothly descends from 1 m altitude to touchdown.

From the beginning of the flare and up to touchdown, it is necessary to scan the area in front of the airplane and to its sides to get a clear view of airplane position and ground surface.

8. After touchdown of the main landing gear, keep the nose in the same position as in the moment of touchdown by slowly pulling back the stick. During this kind of rolling, gaze direction remains the same as during the flare.

9. As soon as the nose gear touches the ground, move gaze forward, release stick to neutral position and start braking by gradually pressing the brake lever – first up to 1.5-2 kg/cm<sup>2</sup> and then further up to 4-5 kg/cm<sup>2</sup>.

### **7.3.2. Correction of wrong landing approach and missed approach procedure**

#### ***Correction of wrong approach***

When all preparations for a correct approach are finished and the airplane is gliding to the runway, the pilot's attention has to be concentrated on the glide point and control of current speed. The location of the point, to which the airplane is descending, has to be continuously re-estimated. This point is defined as a specific place, from which the earth surface "diverges" in all directions, which remains stationary if the pilot does not change the positions of the airplane controls.

If the location of this point is "lower" than the runway threshold (gliding with "underfly"), the pilot has to reduce the gliding angle. Depending on initial gliding conditions (speed, vertical speed, RPM), a correction (gliding angle reduction) can be achieved by either increasing RPM and slightly pulling the stick or simply by pulling the stick without changing RPM.

The first way of "underfly" correction – increasing engine RPM combined with pulling the stick – is used when the airplane is gliding closer to the minimum gliding speed (for example, when the distance to the runway is still large, but speed reaches 250-270 km/h).

The second way – pulling the stick without changing engine RPM – is used when the gliding speed is closer to the maximum gliding speed, i.e. 320-350 km/h.

If the gliding point is "higher" than the runway threshold (gliding with "overfly"), then the pilot's actions should be opposite to the "underfly" corrections.

When the distance to the runway is small or the gliding point is located far away from the runway threshold (more than 100 m) and speed is close to the maximum gliding speed (320-350 km/h), the pilot has to make a decision whether performing a missed approach procedure.

If gliding with "underfly" and all actions to correct the glide path were unsuccessful (the airplane is steadily descending to a point, which is located at some distance from the runway threshold, but speed is already at the minimum gliding speed), it is necessary to make a decision whether performing a missed approach procedure as well.

To ease decision-making on either trying to land the airplane or performing a missed approach procedure, the pilot has to predict the development of the situation in time and space using mental simulations of further airplane movement and his actions under these circumstances.

#### ***Missed approach procedure***

1. If correction was unsuccessful, immediately perform a missed approach procedure.

A missed approach procedure is allowed from any altitude.

2. When the decision to perform a missed approach procedure is taken, increase RPM to takeoff level by moving the throttle lever to the far most position during 1-2 seconds.

Note : It is necessary to remember that from the moment, when the throttle lever is moved to the far most position (from initial 6000 RPM), to the moment when descending stops, the airplane loses 30-40 m of altitude.

Simultaneously with smooth stick movement bring the airplane back from gliding to horizontal level flight with a speed of at least 260 km/h. While climbing from low altitudes, the pilot has to carefully monitor the ground.

3. After reaching 280-300 km/h, start climbing and retract the landing gear by setting the landing gear lever into the УБРАНО (RETRACTED) position.

4. At an altitude of 100-150 m and a speed of at least 300 km/h, retract the flaps by moving the flaps lever into the ПОДЪЕМ (RAISE) position. When the flaps are retracted, set the flaps lever into the НЕЙТР (NEUTRAL) position and repeat the approach.

### **7.3.3. Forces and moments affecting airplane during landing**

#### ***1. Landing flare***

To bring the airplane from descending at a constant gliding angle to the flare, the pilot increases the wing's angle of attack (AOA) by deflecting the elevators upwards. As a result, the lift force increases and becomes bigger than the airplane's weight. Simultaneously, the gravity force component decreases, acting along with the direction of aircraft movement (while descending), and drag increases.

The pilot decreases thrust by reducing engine RPM. As a result, drag becomes higher than thrust. Therefore, the speed is continuously decreasing. At the end of the landing flare, the lift force will become smaller than the weight and the airplane slowly starts descending until the main landing gear touches down.

The speed, at which the flare starts, is very important. It should be within a specific range, which allows reduction of vertical speed by simply pulling the stick. Thus, pulling the stick  $\frac{1}{4}$  -  $\frac{1}{3}$  back should lead to a reduction of translational velocity and not to a climb with subsequent speed reduction.

For the MiG-15bis, this speed is in the range of 230-270 km/h. At higher speeds, a flaring attempt will with a high probability lead to a rapid climb for up to 10-15 m with a subsequent drop, full compression landing gear hit, repeated jump, etc. and to airplane damage. At lower speeds, the probability of stall, uncontrolled roll and airplane damage is very high.

#### ***2. Touchdown and first part of landing run***

Touchdown has to be performed with minimum vertical speed on the two main landing gears. After touchdown, it is recommended to keep the nose wheel

lifted (20-25 cm from the ground) for the fastest reduction of translational velocity.

In the first part of the landing run, the pilot creates a pitching moment by pulling the stick towards him and thus deflecting the elevators, to compensate the diving moment (from unbalanced weight, inertia forces, braking and thrust), thus balancing diving and pitching moments.

### ***3. Second part of landing run***

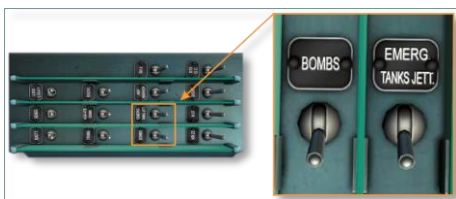
After touchdown of the nose gear, it is necessary to return the stick to the neutral position and start braking.

Friction force increases drastically because of the decrease of the lifting force and due to brake usage. Thus, the deceleration rate increases and the airplane's speed is reduced.

## ***7.4. Pilot actions when flying with drop tanks***

### **7.4.1. Before takeoff**

1. On the right electrical panel, enable the БОМБЫ (BOMBS) and АВАРИЙН СБРОС БАК. (EMERGENCY DROP TANKS RELEASE) ACBs.



2. Enable the following switches on the armament control panel:

ТАКТИЧЕСКИЙ СБРОС ВКЛЮЧЕН НА ВЗРЫВ (tactical release with explosion, bombs armed)



### СИГНАЛИЗ. ПОДВ. БАКОВ (DROP TANKS SIGNALIZATION)



Before taxiing, check if the empty drop tank indication light on the armament control panel, labeled ПОДВ. БАКИ (DROP TANKS), illuminates at idle mode. Remember that at low (less than 6.000) engine RPM, the light may illuminate in spite of the presence of fuel in external tanks, because of insufficient pressurization of fuel in the external tanks.



When increasing engine RPM to more than 6000, the lamp should go off to indicate that fuel is supplied from the external tanks.

When fuel from the drop tanks is depleted, the lamp will illuminate when RPM are at least 6000.

3. Extend flaps to 20°.

### 7.4.2. While flying

While flying with external drop tanks, it is not allowed to exceed more than 5G and 800 km/h IAS.

### 7.4.3. Drop tanks release

The recommended airspeeds (IAS) for a safe release of drop tanks are:

- unified 400 liter tanks – 350-390 km/h;
- tanks with stabilizer – at least 400 km/h;
- tanks without stabilizer – at least 650 km/h.

1. Open the safety cover on the bomb armament panel and then press the emergency release button, labeled АВАР. СБРОС БОМБ (EMERGENCY BOMB RELEASE) to release the drop tanks.



2. Check visually if tanks were released.

Instead of 1. it is also possible to release the tanks using the tactical release button on the stick:

- a) Enable the БОМБЫ (BOMBS) ACB on the right electrical panel;
- b) Press the tactical release button.

After release of the tanks, disable the following switches:

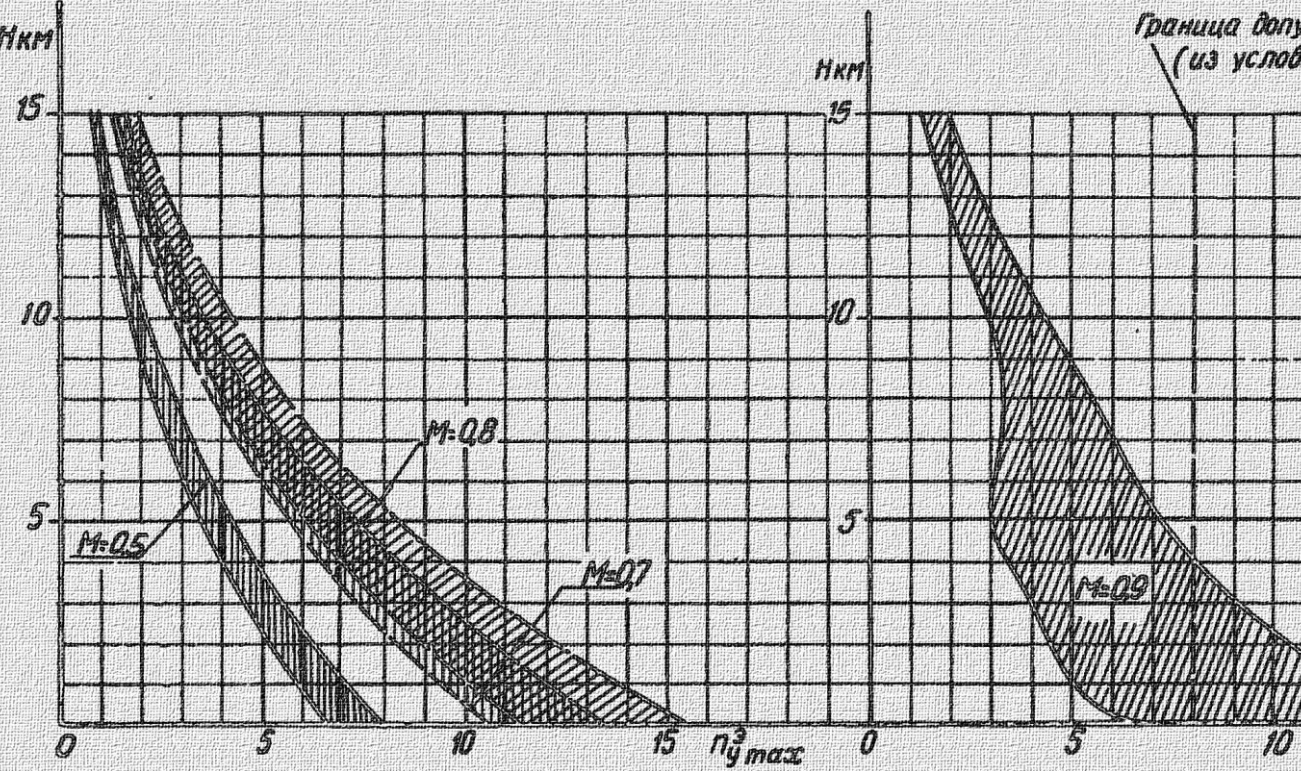
- On the bomb armament panel:
  - ТАКТИЧЕСКИЙ СБРОС ВКЛЮЧЕН НА ВЗРЫВ (tactical release with explosion, bombs armed)
  - СИГНАЛИЗ. ПОДВ. БАКОВ (DROP TANKS SIGNALIZATION)
- On the right electrical panel:
  - БОМБЫ (BOMBS)

- АВАРИЙН СБРОС БАК. (EMERGENCY DROP TANKS RELEASE).

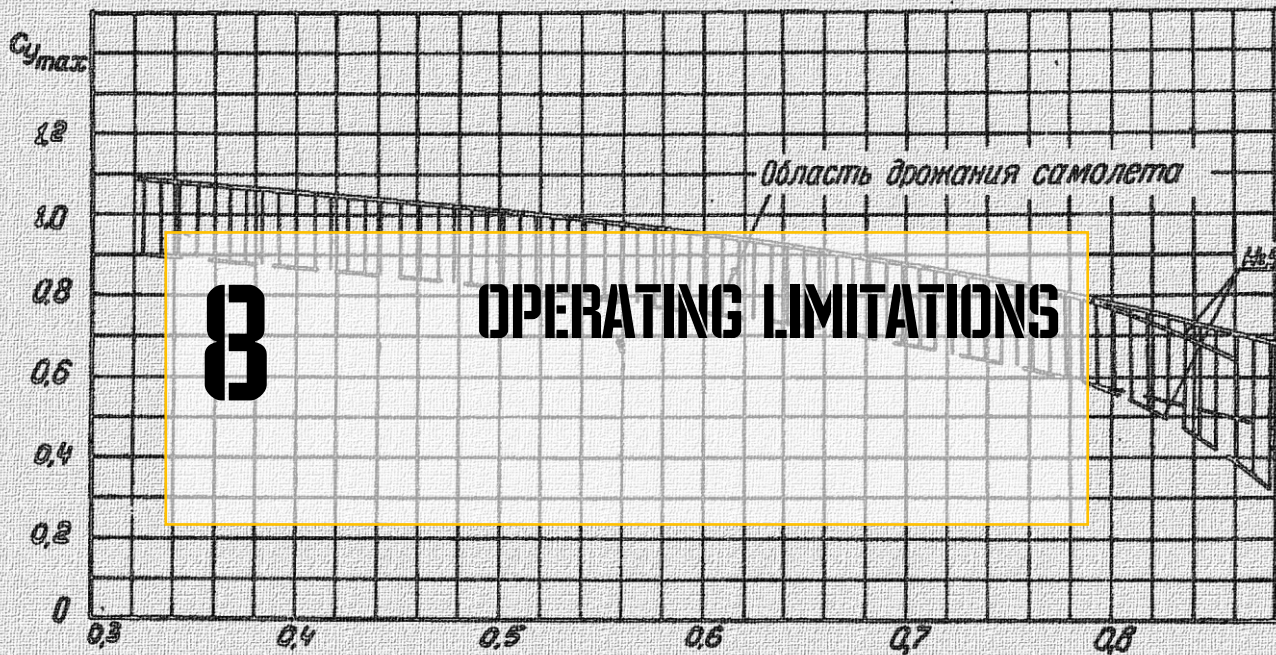
### ***7.5. Engine shutdown***

After taxiing to the parking area, the following actions have to be performed:

1. Pull the throttle lever all the way back and start the stopwatch. Before shutdown, the engine has to be cooled down at least 30 seconds.
2. Switch off the ARK-5 on the K-7 panel and the headlight on the instrument panel.
3. Close the shut-off valve.
4. Switch off all ACBs on the left and right electrical panels, except the АККУМУЛЯТОР (ACCUMULATOR/BATTERY) and ПОМПА 2-го БАКА СИГНАЛ ПОМПЫ (SECOND/REAR TANK PUMP, PUMP SIGNAL) ACBs. When the engine compressor stops rotating, switch off the remaining ACBs.



Фиг. 184. Максимально возможные перегрузки самолета (значения  $n^3$  для  $n^2_{max}$  подсчитаны по  $c_{y_{max}}$ , полученному на  $H=5200$  м).  
Самолет МиГ-15 с РД-45Ф.



Фиг. 185. Коэффициент максимальной подъемной силы самолета.



## 8. OPERATING LIMITATIONS

### 8.1.1. Primary limitations

Maximum load limit (G) for all altitudes: 8

Critical (structural failure) maximum load limit (G): 12

Maximum indicated airspeed (IAS): 1070 km/h

Maximum Mach number (M): 1.0

Maximum air velocity pressure: 5500 kg/m<sup>2</sup>

Service ceiling: 15500 m

The maximum load limit of 8 G can only be attained at altitudes below 6400 m. When maximum G for a given altitude and airspeed is approached, the aircraft exhibits a buffet, which can serve as a maximum G warning for the pilot.

### 8.1.2. Maximum airspeed and Mach number (M) limitations

Absolute maximum attainable airspeed in level flight:

- at low altitudes:
  - TAS (true airspeed, small needle on the airspeed indicator): 1070 km/h
  - IAS (indicated airspeed, large needle on the airspeed indicator): 1060 km/h
- at the service ceiling:
  - TAS: 720 km/h
  - IAS: 300 km/h

Absolute maximum attainable Mach number (M):

- in level flight (attained at an altitude of 11000 m): 0.919
- at low altitudes: 0.877
- at the service ceiling: 0.7

Indicated airspeed limitations:

- IAS 1070 km/h from ground altitude to 900 m
- Maximum airspeed with flaps fully extended to 55°: IAS 400 km/h

- Maximum airspeed for landing gear extension/retraction: IAS 500 km/h

Maximum level flight airspeed with external drop tanks:

- small drop tanks (2 x 300 l):
  - 3500 m: TAS 820 km/h (IAS 700 km/h)
  - 5000 m: TAS 1015 km/h
- large drop tanks (2 x 600 l):
  - 4600 m: TAS 990 km/h (IAS 800 km/h)

Maximum Mach number with external drop tanks:

- small drop tanks (2 x 300 l): M = 0.9
- large drop tanks (2 x 600 l): M = 0.85

Maximum level flight airspeed with open air brakes:

- ground altitude: TAS 750 km/h (IAS 750 km/h)
- 10000 m: TAS 790 km/h (IAS 482 km/h)

The air brakes produce a positive pitch moment, which can be used to assist with dive recovery.

NOTE: The DCS: MiG-15bis model features enlarged air brakes with a surface area of 0.8 m<sup>2</sup> featured on airframes produced from 1952.

The optimum climbing speed without external drop tanks is practically identical at all altitudes and equals TAS 710 km/h, however the corresponding indicated airspeed drops as altitude increases (to IAS 300 km/h at the service ceiling).

Service ceiling (Vy (climb rate) of 0.5 m/s):

- Without drop tanks: 15000 m
- With drop tanks: 13400 m

### 8.1.3. Minimum airspeed limitations

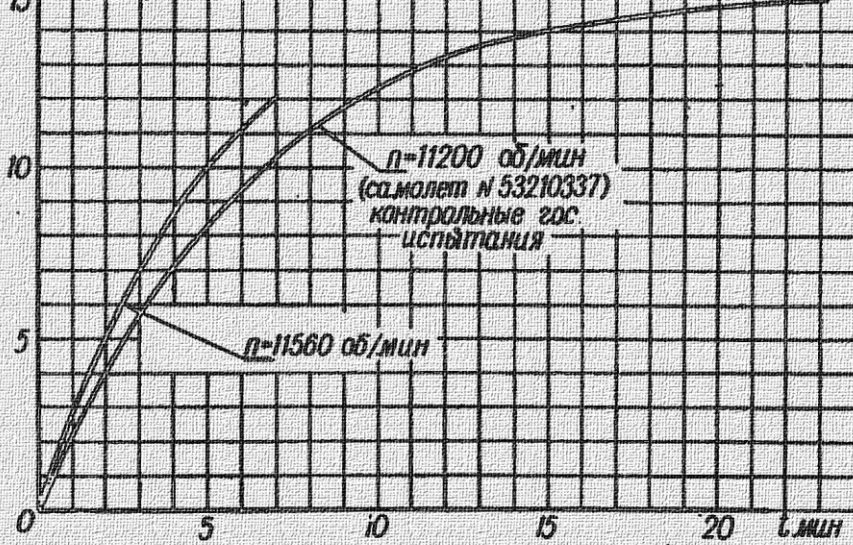
The minimum airspeeds (indicated) at which the aircraft loses controllability and stalls are as follows, depending on engine power setting:

- idle power, flaps and landing gear extended: 190 km/h;
- idle power, flaps and landing gear retracted:
  - below 10000 m: 200 - 220 km/h;
  - above 10000 m: 230 - 240 km/h;
- idle power, air brakes open: 200 - 210 km/h;

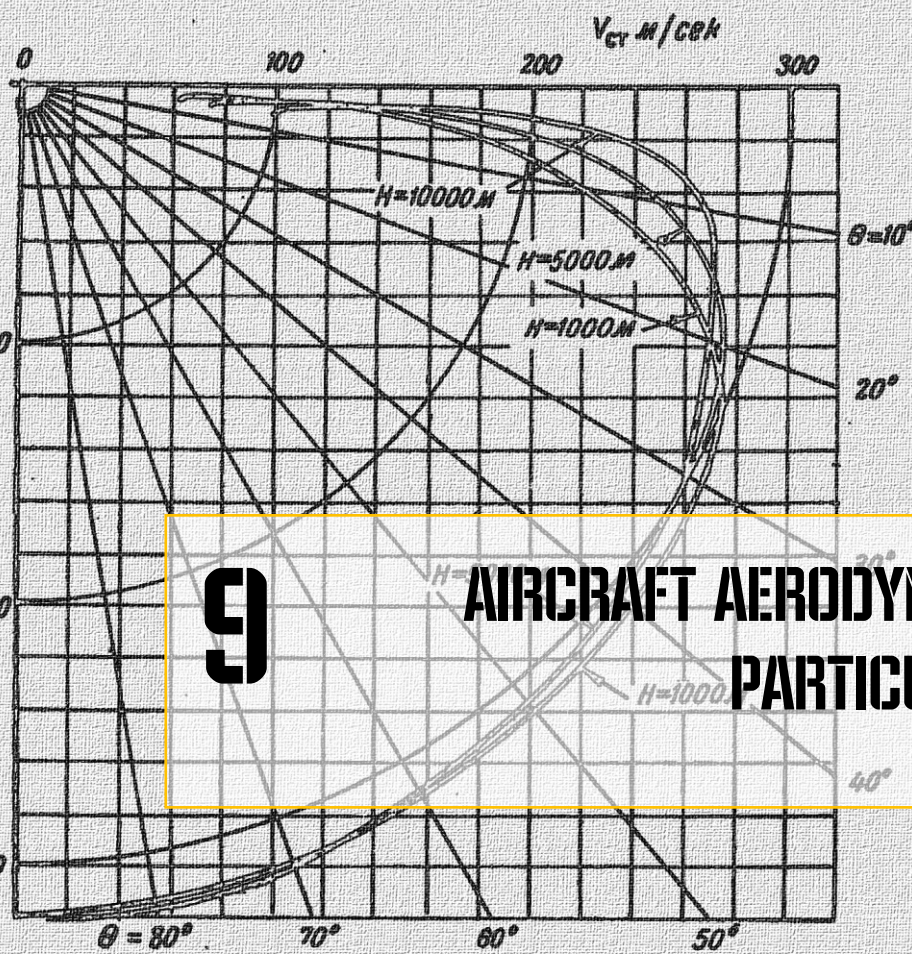
- max power, climbing, flaps and landing gear retracted: 200 km/h.

The minimum control speed at which the control surfaces retain sufficient effectiveness is 300 km/h at altitudes above 12000 m.

The minimum speed for level flight and maneuvering, except takeoff and landing, is set for the aircraft at IAS 300 km/h.

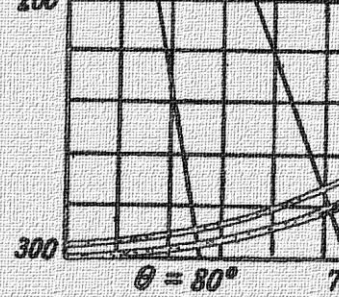


Фиг. 20. Время набора высоты самолетом.

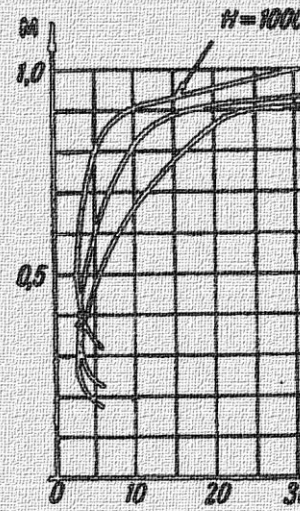


**9 AIRCRAFT AERODYNAMIC PARTICULARS**

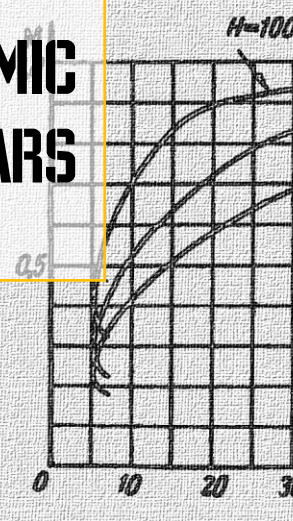
Фиг. 21. Указательница глссад планирования самолета без тормозных щитков (по расчету). Малый газ



Фиг. 22. Указатель с тормозными щитками (P<sub>мал. газ</sub> = 75 кг); G<sub>1</sub>



Фиг. 23. Числа M (пикирования) (по расчету). Малый газ G<sub>2</sub> = 4



## 9. AIRCRAFT AERODYNAMIC PARTICULARS

The aerodynamic characteristics and handling particulars described below are based on the SA-64 standard atmosphere model: +15°C, 760 mmHg at sea level.

### 9.1.1. Climb rate

Time to climb to 5000 m: 1.95 min

Time to climb to 10000 m: 4.9 min

Climb rate reduces significantly as altitude increases. Maximum climb rate is attained at ground altitude: 50 m/s (36.6 m/s with large drop tanks).

### 9.1.2. Takeoff and landing characteristics

#### *Primary airspeed references for takeoff and landing*

Takeoff ground run distance: (flaps extended to 20°) – 475 m.

Liftoff speed without drop tanks and flaps extended to 20° is 220 - 230 km/h, with flaps retracted 245 km/h.

Liftoff speed with large drop tanks and flaps extended to 20° is 255 km/h, with flaps retracted 275 km/h.

Final approach speed (prior to flare) with flaps extended to 55° at idle engine power is 250 - 270 km/h.

Touchdown speed with flaps extended to 55°, idle engine power, and at normal landing weight is 190 - 200 km/h.

Landing ground run distance (flaps extended to 55°) – 670 m.

#### *Other takeoff particulars*

The takeoff distance and liftoff speed depend on engine RPM setting, flaps setting, and takeoff weight of the aircraft.

From a stopped position, the aircraft is initiated into forward motion at approximately 8000 - 9000 RPM, but can be held in place using the wheel brakes unless engine power is increased further.

Nose wheel liftoff speed is approximately 160 km/h.

After liftoff, the landing gear is retracted at 350 - 400 km/h at an altitude of 10 - 15 m. The landing gear transition time is 6 - 8 sec.

Flaps are retracted at an altitude of 50 - 100 m (after retracting the landing gear).

The ground run distance depends on the type of runway surface and its condition, as well as wheel brake usage.

### ***Other landing particulars***

Prior to landing, the landing gear is extended at 400 - 450 km/h (transition time of 8 - 10 sec). The landing approach is initiated at an airspeed of 320 - 350 km/h. Flaps are extended during the approach.

Final approach speed is 250 - 270 km/h, depending on aircraft weight.

The flare is performed at an altitude of 6 - 7 m and completed at 1 m. The engine is set to idle power and the aircraft is held level by applying increasing stick pull to reduce airspeed to the desired touchdown speed of 190 - 200 km/h (depending on weight).

### **9.1.3. Controllability**

The MiG-15 powered by the VK-1 engine can perform all standard aircraft maneuvers. No special handling particulars are exhibited up to Mach 0.86 - 0.87.

At airspeeds exceeding Mach 0.86 - 0.87, the following particulars are exhibited:

- a) opposite roll response to pedal input (for example right pedal input leading to left roll);
- b) slight reduction of stick force in straight flight;
- c) increase of stick force required to attain a unit of load (G);
- d) uncommanded roll.

### ***Pitch trim particulars***

- Neutral trim airspeed when climbing at altitudes of 3000 - 5000 m at normal aircraft weights with elevator trim set to neutral and engine power set to nominal 11200 RPM is 520 - 600 km/h.

- At altitudes of 3000 - 7000 m throughout the airspeed envelope, the longitudinal stick force required to operate the elevator does not exhibit significant change and use of elevator trim is not required.
- At altitudes below 3000 m and airspeeds approaching maximum, the recommended IAS for establishing elevator trim is 800 km/h.
- At altitudes above 10000 m, the recommended IAS for establishing elevator trim is 350 km/h.

#### **9.1.4. Response to rudder deflection**

Aircraft roll response to rudder input in level flight at speeds above 300 km/h corresponds to the direction of pedal input, but is relatively mild due to the wing anhedral angle. However, as G increases, this effect becomes more pronounced. As airspeed increases toward Mach 0.84 - 0.86, the roll rate in response to pedal input begins to reduce noticeably. In the Mach 0.87 - 0.95 range, roll response becomes opposite of pedal input. This effect is related to the swept wing design and is caused by reverse roll moments produced by uneven aerodynamic forces of the left and right wing under slip conditions at critical Mach speeds.

#### **9.1.5. Uncommanded roll**

Uncommanded roll can occur at high flight speeds throughout the altitude envelope. At altitudes below 4000 m, this can occur at TAS greater than 1070 - 1090 km/h (small needle on the airspeed indicator). As altitude increases, the true airspeed, at which uncommanded roll can occur, decreases. At altitudes above 11000 m, the true airspeed, at which uncommanded roll can occur, stabilizes in the 1010 - 1090 km/h range.

Uncommanded roll is corrected by applying opposite stick deflection to maintain the desired roll angle.

It's important to remember:

- a) If for some reason TAS exceeds 1070 km/h, the aircraft must be slowed by opening the air brakes and reducing engine power to idle.
- b) When applying G (pulling the stick) while flying at speeds approaching maximum for the given altitude, anticipate possible uncommanded roll. In this case, reduce G (reduce stick pull), open the air brakes, then proceed to apply the desired G again.

- c) Applying opposite pedal during uncommanded roll at speeds of Mach 0.86 and greater in an attempt to correct the effect can lead to *increased* roll rate and significant lateral stick force. Roll can be reduced in this case by carefully applying pedal *in the direction* of the roll. For example, if uncommanded roll is to the left, apply slight left pedal or if uncommanded roll is to the right, apply slight right pedal.

The reasons behind the uncommanded roll condition lie in the technological limitations of aircraft production of the 1950s. It was impossible to produce perfectly symmetrical wing forms for the left and right wings with identical rigidity. At high speeds, the wings are stressed and subject to bending and turning deformation at different amplitudes for the left and right wing due to their slight variance in rigidity. Furthermore, in the transonic speed range, shock waves are not formed simultaneously on both wings due to slight variance in their surface fairings and thicknesses. The lift produced by the wing which experiences transonic shock waves first is immediately reduced compared to the other wing. The resulting variances in angles of attack and shock wave conditions between the two wings produce an unbalanced lateral force and a roll moment uncommanded by the pilot.

**Note:** All production airframes delivered to the air force were test flown by experienced pilots to determine the specific speed at which the uncommanded roll condition begins to occur.

For increased gameplay dynamics, the DCS: MiG-15bis model features a randomized wing rigidity calculation. As such, the specific airspeed, at which uncommanded roll occurs, and its intensity depend on flight conditions, however the direction of the roll condition (left or right) is randomized with each aircraft "spawn".

### 9.1.6. Stall and spin

For the minimum indicated airspeed at which the aircraft loses controllability and stalls, see section [Minimum airspeed limitations](#).

Flight at speeds below the minimum allowed airspeed results in progressively worsening flight controllability as airspeed drops. At IAS 210 - 220 km/h (large needle on the airspeed indicator) in level flight with the pedals held neutral, the aircraft tends to gently roll to either side, drop the nose below the horizon, lose altitude, but does not enter into a spin. If the control stick is pushed forward to the neutral or slightly forward of neutral position, the aircraft begins to quickly gain airspeed, regain full controllability and maintain straight flight.



If airspeed is reduced by positive G application (pulling of the stick), the aircraft exhibits a buffet 10 - 15 km/h prior to reaching minimum allowed airspeeds. The buffet increases as minimum speed is approached and aileron control becomes increasingly ineffective.

In the buffet phase, a spin can be initiated by pulling the stick fully back and applying full rudder pedal. Initially the aircraft will roll in the direction opposite of pedal input (especially likely in a left spin condition), then pitch down and begin to spin in the direction of pedal input.

The spin can be further aggravated by applying full stick deflection in the direction opposite of pedal input as the spin is initiated.

During landing approach with the landing gear and flaps extended, the aircraft maintains stable flight down to IAS 190 km/h. At this speed, the aircraft exhibits a characteristic buffet as it begins to "wallow" from one wing to the other and can stall in either direction.

At flight speeds above minimum, if the stick is pulled back with simultaneous pedal input, the aircraft performs a wide barrel roll and enters a spin, gradually leveling the spin axis with the horizon.

### ***Stall recovery***

If airspeed drops below minimum for the current flight condition and the stall warning buffet appears, recovery is accomplished by gradual stick forward application and increase of engine power to begin acceleration. As airspeed and controllability is regained, pitch can be increased to attain level flight and continue acceleration to establish the desired flight parameters.

If a stall occurs, pedals are maintained in the neutral position to avoid entry into a spin and the stick is held neutral or forward of neutral. Level flight can be established as airspeed increases above minimum.

### ***Spin recovery***

As the aircraft enters into a spin:

- a) determine the direction of the spin
- b) set idle engine power
- c) set control stick to neutral (the cockpit features a white line on the instrument panel to help guide the pilot to the neutral position)

d) apply pedal in the direction opposite of the direction of the spin.

As the aircraft ceases to spin, it will begin to recover airspeed. As IAS 380 km/h (large needle on the airspeed indicator) or greater is reached, complete the recovery by establishing level flight.

### **9.1.7. Other aerodynamic particulars**

Of note is the gradual  $C_y$  (lift coefficient) curve beyond critical angles of attack, which provides for safe flight in regards to a stall of either wing.

Optimum aerodynamic efficiency (lift/drag ratio) with retracted flaps equals 14.6 at Mach 0.6,  $C_y = 0.45$ ,  $H$  (altitude) = 0.

Minimum frontal drag  $C_{xmin}$  equals 0.015 at Mach 0.6,  $C_y = 0$ ,  $H = 0$ .

The aircraft exhibits lateral-directional stability throughout the allowed angle of attack envelope, flight control deflection range, and Mach number envelope. The elevators maintain effectiveness.

The aircraft maintains lateral-directional stability and the ailerons and rudder maintain effectiveness throughout the angle of attack envelope and flight control deflection range. The elevators maintain effectiveness throughout the Mach number envelope up to Mach 0.92.

At Mach > 0.92, aileron effectiveness greatly reduces. At low angles of attack ( $1.5^\circ$ ), ailerons effectiveness is practically zero in the Mach 0.96 - 0.98 speed range.



**10**

**COMBAT EMPLOYMENT**

## 10. COMBAT EMPLOYMENT

### ***10.1. ASP-3N gunsight distance measuring device usage***

In the ASP-3N gunsight, the angular size of the optical rangefinder circle mesh, formed by diamonds, can vary from 17.5 to 122 mil. Targets with sizes from 14 to 22 m fit into this circle at distances from 180 to 800 m. To fit targets with sizes from 7 to 45 m, it would be necessary to develop a rangefinder with the grid mesh varying from 8 to 250 mil and lead to noticeably bigger gunsight dimensions.

The operating range of the ASP-3N rangefinder provides aimed fire at aerial targets at ranges most likely found in combat. To reduce distance calculation errors due to target visible size change under different shooting angles, the average angle (1/4) for the most probable shooting angles (from 2/4 to 0/4) is taken into account. Therefore, there is no need to do an additional adjustment based on target view angle.

Dependence of operating ranges for accurate distance measurement on wingspan / target base is depicted in Figure 10.1. The horizontal axis is the distance  $D$  to the target in meters (m), the vertical axis is the wingspan / target base  $b_t$  in meters (m). Taking into account that angular target size depends on both target base and distance, it is recommended to determine distances for accurate rangefinder operation based on target data (target base) during preparation to the flight.

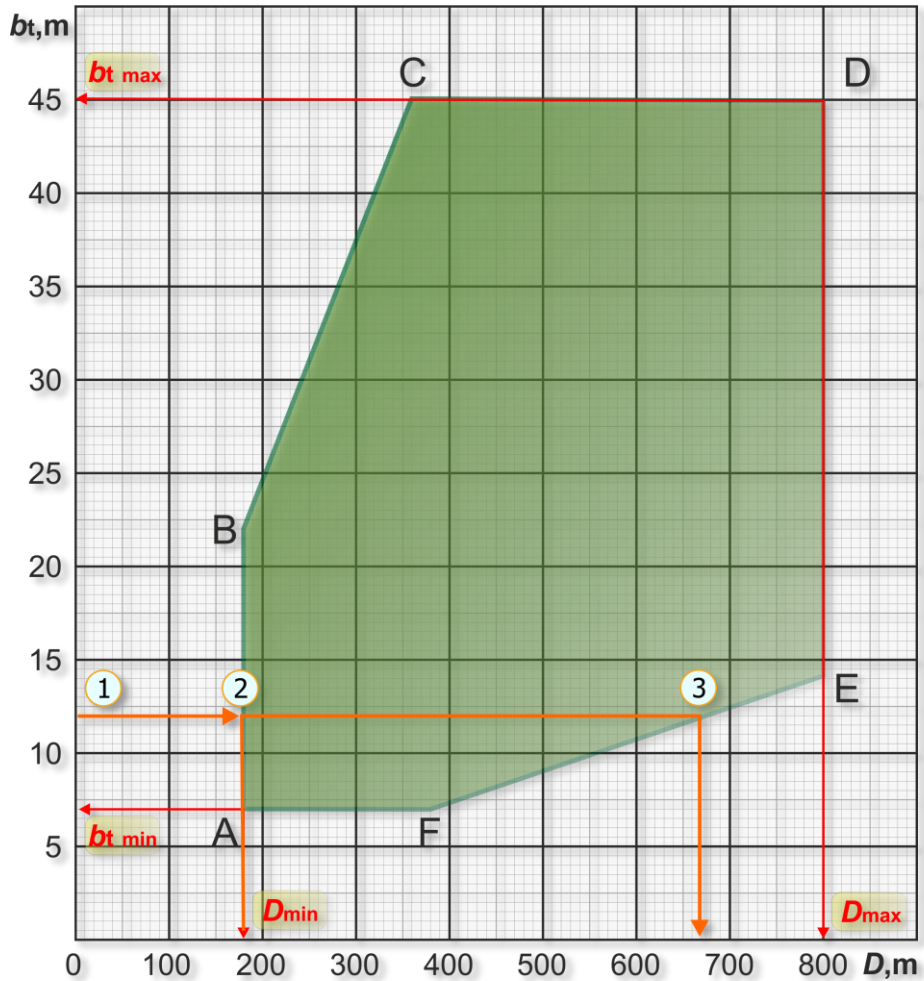


Figure 10.1. Dependence of operating ranges for accurate distance measurement on wingspan/target base

***Procedure for finding operating ranges for accurate distance measurement***

**TASK:** The target datum is 12 m. Determine the range interval for precise operation of the ASP-3N.

1. In accordance with the known target datum (in m) represented on the vertical axis, draw a horizontal line until it intersects the ABCDEF polygon.
2. From the intersecting point of the ABC segment, drop a perpendicular to the range axis to obtain the minimum range value (180 m).
3. From the intersecting point of the DEF segment, drop a perpendicular to the range axis to obtain the maximum range value (670 m).

When parameters of the datum or range differ from the calculated ones, inaccuracy will reveal itself as the impossibility to frame the target when rotating the handle to increase the range (irremovable yawn between the diamonds and target will remain) or as placing the range to the locking stop with the target size surpassing the diamonds when rotating the handle to decrease the range.

[Return to Aiming technique with the use of the gyro gunsight diagram](#)

### **10.1.1. Shooting at aerial targets**

See [Figure 5.15](#)

### **10.1.2. Shooting at ground targets**

When shooting at ground targets with sizes of more than 14 m, it is necessary to set the target base, corresponding to the target dimensions, and before diving set the gunsight to the minimum distance. After the turn towards the target with the minimum distance set in the gunsight, the pilot has to put the reticle over the target and keeping it in this position, continue diving for 1-2 seconds. Set the maximum distance by rotating the handle and shoot a short burst when the target is framed by the diamond circle. Immediately after that, start exiting from dive and set the minimum distance on the gunsight.

When shooting at ground targets with sizes of more than 18 m at higher speeds or with drop tanks (non-empty) from approximately 1000 m distance, it is recommended to set a target base which is 20% less than the true size of the target. Start shooting when the target is framed accurately.

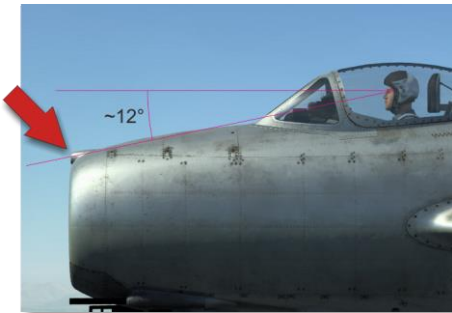
When shooting at ground targets with sizes less than 14 m, set 14 m target base on the gunsight. Rangefinder operation is similar to the one described above.

The shooting moment is determined based on target position in the aiming mesh at a distance of 800 m (i.e. rotating handle is on detent). Never should the pilot wait for precise target framing, because distance in this case will be as many times less than 800 m, how many times the size of the target is less than 14 m.

When shooting at small dimension targets at higher speed or with drop tanks (with fuel) present, from approximately 1000 m, the moment of shooting can be determined based on central aiming mark projection onto the target, taking into account that angular size of central mark is 2 mil. For example, when shooting at a car from a distance of 1000 m, central mark projection diameter is approximately equal to the transverse dimension of the car.

## ***10.2. Bombing aiming***

The MiG-15 is not equipped with a specialized bombsight. To use bombs, the pilot must aim visually. This is the skill that can be improved by practicing. The line extending the pilot's eye and passing through the gun camera S-13 lens location is used for aiming:



### ***Procedure for bombing aiming and release***

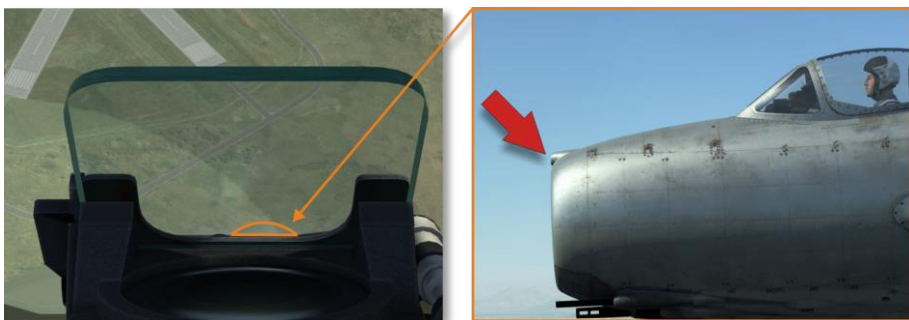
1. To have a better view on the target, it is advisable to fly to the target area with such a heading relative to the target that the target "moves" along the canopy side window to the left bottom corner of the non-movable part of the canopy.



Optimal altitude is 2000-2200 m and speed is about 400 km/h.

2. When the target line of sight is close to 10 or 2 o'clock, the pilot has to do the following:

- set engine RPM to at least 6000;
- establish line of sight of the airplane nose by lifting the pilot's head, as shown on the picture, by pressing `|RShift + RCtrl + Num8|`:



3. When the target line of sight is at 10 or 2 o'clock, roll the airplane toward the target with 45-50° roll angle and simultaneously start diving with 30-45°.

4. Exit from the roll has to be performed in advance (lead angle equals to roll angle). Correct nose deflection from the target in a way that target starts moving towards the line "eye – S-13 gun camera lens location".

5. At an altitude of 800-1200 m, release the bombs `|RAlt + Space|`. While diving, speed is increasing up to 500-550 km/h. Do not exceed a speed of 600 km/h (use air brakes).

6. Retract air brake while egressing from the bombing run.



To have a consistent result, practicing is required. It is crucial to know that:

- increased speed while releasing bombs leads to increased bomb overfly (projection of the trajectory of the falling bomb on the horizontal surface);
- reduction of dive angle leads to bomb overfly;
- increasing of bomb release altitude with the same diving angle leads to bomb underfly.



**11**

**FEATURES  
OF DCS: MiG-15bis**

## 11. FEATURES OF DCS: MiG-15bis

	<b>MODEL FEATURE</b>	<b>CAUSE</b>	<b>NOTE</b>
1.	A cold start is possible only if connected to external electrical power.	"Weak" battery	Later production airframes of the MiG-15bis were fitted with two batteries to allow for autonomous starting.
2.	It is impossible to start the engine if the throttle is forward of the full back (idle) position.	No power is provided to the starting system if the throttle is out of the full back position (a contact switch is installed for this purpose).	The throttle must be full back to initiate the starting sequence. Once started, the starting system is powered bypassing the throttle contact switch.
3.	Engine start button must be pressed for at least 1 second for a successful start.	Safety feature of the starting system to prevent accidental activation.	
4.	Start failure if fuel shut-off valve is opened too quickly in the second stage of engine start or if completely open prior to initiating start.	The starting sequence is only partially automated. Fuel is "metered" to the combustion chambers manually by the pilot.	In case of EGT spike and RPM hanging, adjust the shut-off valve to limit fuel flow (slightly move toward closing position). Once EGT is normalized (below 650°C), continue the start by gradually opening the shut-off valve.
5.	Engine surge when throttle is aggressively moved forward between idle and 5000 RPM settings.	Engine acceleration control unit functions correctly between 5000 RPM and max power settings.	In case of engine surge, set throttle to idle. Once normalized EGT (below 590°C) and idle RPM are achieved, gradually move throttle forward to attain desired power setting.

	<b>MODEL FEATURE</b>	<b>CAUSE</b>	<b>NOTE</b>
6.	Engine surge when throttle is aggressively moved forward between 5000 RPM and max power settings while the isolating valve is turned ON.	When the isolating valve is turned on, the engine acceleration unit and the barostatic regulator of the fuel supply system are disabled. The pilot manually controls fuel supply to the engine.	Set throttle to idle until engine surge ceases. Once EGT and RPM are normalized, gradually increase power to attain desired power setting.
7.	Pilot can request ground crew to set wheel chocks.	Required for engine ground run-ups to max power setting.	The wheel brakes provide sufficient stopping power only up to 10.000 RPM engine power setting.
8.	Pilot loss of consciousness at altitudes above 10000 m if cockpit is not pressurized.	Hypoxia due to low ambient air pressure despite oxygen flow directly to the pilot.	Cockpit must be pressurized during high altitude operations.
9.	Worsening pilot condition at altitudes above 8000 m if oxygen is not supplied.	Hypoxia due to low oxygen content in the pilot's air supply.	Oxygen must be supplied via the corresponding valve in the cockpit during high altitude operations.
10.	Canopy cannot be opened when the cockpit is pressurized.	When expanded under pressure, the cockpit pressurization lines "push" the canopy upward and "jam" the canopy locks. Forced depressurization (like in the F-86 Sabre) is not provided.	Depressurize the cockpit using the corresponding valve in the cockpit, then open the canopy as normal using the canopy opening handle(s).
11.	The canopy is held open by a dedicated latch. The canopy opening handles cannot be used to close the canopy.	Design particular.	To close the canopy, pull the handle located along the top of the moving canopy bow railing.
12.	ARK-5, bandwidth selector panel (left cockpit side, behind the throttle): selection of more than one bandwidth is prohibited.	Failure of the electric motor responsible for bandwidth selection control.	

	<b>MODEL FEATURE</b>	<b>CAUSE</b>	<b>NOTE</b>
13.	RSI-6 shortwave radio: contact frequency is set via channel selection. Setting of correct frequency for ATC contact requires using dedicated frequency table with list of airport frequencies and corresponding RSI-6 channels.	Corresponds to the operational radio procedures of the MiG-15 era.	The transmitter and receiver are tuned separately. As a gameplay assist, it's possible to tune both simultaneously. Tuning is accomplished via the control panel on the left cockpit side, behind the throttle. Additionally, current frequency setting is displayed on the kneeboard indicator <b>[RShift + K]</b> or <b>[K]</b> .
14.	Air brake extension time is limited to 7 minutes.	Failure of the electrohydraulic air brake actuator. Results in closing of the air brakes under airflow pressure and inability to be opened again.	Monitor the extension time when operating the air brakes via the air brake switch located on the left cockpit side, which maintains the air brakes in the set position <b>[RCtrl + B]</b> . For short use of the air brakes, use the air brake switch on the flight control stick instead <b>[B]</b> , which only extends the air brakes while the switch is pressed and retracts them when released.
15.	During landing approach, flaps will not extend if set immediately to the 55° landing position.	In the retracted position, flap extension locks are released when the flap control handle is set to the 20° position for at least 1-2 sec.	To lower the flaps from the retracted position, first set the flap control handle to the 20° position for at least 1-2 sec, then to the 55° position for full extension.

	<b>MODEL FEATURE</b>	<b>CAUSE</b>	<b>NOTE</b>
16.	Emergency flap extension is possible only if the flap control handle is set to the NEUTRAL or 55° position.	Under emergency release by the pneumatic system, flap extension locks are released and will allow flaps to be extended down to the 55° position.	If the flap control handle is set to RETRACTED or 20° position, the flaps will not extend (fluid will not drain from the retracting chamber).
17.	Flap position (extension) can be verified using the mechanical pop-up indicator on the left wing.	The flaps extended light in the cockpit only illuminates when flaps are in the 55° position.	Useful for verifying flap position when in the 20° setting. The cockpit light does not illuminate, but actual flap setting can be verified using the wing mechanical indicator.
18.	Landing gear extension can be verified using the mechanical pop-up indicators on each wing and in front of the canopy.		Successful landing gear extension and locking is also indicated by the landing gear status lights (three green) on the cockpit instrument panel.
19.	When turning on the UV-cockpit lights, holding the rheostat in the ENERGIZING position (full right turn of the rheostat) for over 30 seconds can lead to burning out of the bulbs.	In ENERGIZING mode, maximum current is applied to a coil and bimetal plate. The coil heats the bimetal plate, mercury and argon gases. After 15 seconds, the bimetal plate breaks the circuit and an contact arc discharge between the coil and ring "replaces" it to energize the mercury and argon gases. If maximum energy is continuously applied to the lamp, the coil may burn out.	When turning the lamp(s) on, hold the rheostat in the ENERGIZE position for no more than 3-5 sec, then turn slightly down (left). The lamp illuminates gradually within 10-15 sec.

	<b>MODEL FEATURE</b>	<b>CAUSE</b>	<b>NOTE</b>
20.	Landing gear control handle latch	Used to prevent accidental landing gear retraction on the ground.	After engine start and extension of flaps, prior to taxi, open the latch by moving it to the left to allow the landing gear control handle to be operated during takeoff. The latch is not used in flight (do not latch the control handle in flight).
21.	Gun safety switch on the flight control stick	Used to prevent accidental gun fire	If starting the mission on the ground, the gun safety switch must be lifted to allow for gun fire [LCtrl + Space]. When lifted, the switch "flips" from the top of the grip to the forefront and becomes a "trigger", which the pilot squeezes to press the 23 mm cannon fire switch.
22.	Cannon charging switches	Used to charge the gun systems	If starting a mission on the ground, each gun (2 x 23 mm, 1 x 37 mm) must be charged by pressing and holding the corresponding charging button for at least 3 sec to load an initial round into the guns.
23.	After retracting the flaps or their full extension to the 55° position, set the flaps control handle to the NEUTRAL position.	In the retracted and fully extended positions, the flaps are held in place by hydromechanical locks.	When set to the NEUTRAL position, the hydraulic pressure in the flap actuator lines is released to prevent fluid leakage.

	<b>MODEL FEATURE</b>	<b>CAUSE</b>	<b>NOTE</b>
24.	In the 20° flap position, flaps are held in place using hydraulic pressure. DO NOT set the flap control handle to the NEUTRAL position in this case.	Flaps will be pushed upward (raised) toward the wing by airflow pressure if hydraulic pressure is released as a result of setting the flap control handle to the NEUTRAL position.	
25.	With flaps extended to the 55° position, maintain airspeed below 400 km/h indicated (wide arrow on the airspeed indicator).	In the 55° landing position, flaps are held in place by hydromechanical locks, which can be damaged by excessive pressure produced by oncoming airflow at high speeds.	Damage to the flap actuators may result in failure to retract one of the flaps.
26.	Transitioning (lowering / raising) the landing gear at airspeeds exceeding 500 km/h indicated (wide arrow on the airspeed indicator) may result in damaging the landing gear or a failure of the hydraulic system.	At airspeeds exceeding 500 km/h, the landing gear mechanisms undergo excessive loads, which can cause damage and lead to hydraulic fluid leakage with resulting loss of hydraulic pressure down to 0.	When extended, the landing gear is locked by mechanical locks. Airspeed is limited only by the additional drag produced by the extended landing gear.
27.	Instrument flight in cloudy or nighttime conditions is difficult (impossible).	The AGK-47B attitude indicator is limited in roll and pitch indication ( $\pm 95^\circ$ in roll, $\pm 85^\circ$ in pitch).	Later production airframes of the MiG-15bis (post Korean war) were fitted with the AGI-1 attitude indicator, which provided unlimited attitude indication.



	<b>MODEL FEATURE</b>	<b>CAUSE</b>	<b>NOTE</b>
28.	Throughout the flight altitude envelope, approaching maximum airspeed may lead to uncommanded roll of the aircraft. This tendency increases with positive G loading.	The technology available during the MiG-15 design era did not allow for complete symmetry in the construction of the left and right wings. When maximum loads are approached, the dissymmetry of the wings produces unbalanced lateral forces leading to rolling tendencies.	Countering the uncommanded roll required reducing airspeed by reducing engine power and/or opening the air brakes. Attempting to reduce airspeed by increasing pitch (pulling up) will increase the positive G load, which only worsens the rolling condition.  The simulation randomizes the dissymmetry of the left and right wings during aircraft "spawn".
29.	At airspeeds of Mach 0.86 and greater, pedal input produces opposite roll response.	Particulars of swept wing aerodynamics.	This effect can be used to counter the high airspeed uncommanded roll, in particular when aggravated by positive G load.
30.	At airspeeds of Mach 0.93 and greater (possible only in a dive), the aircraft exhibits a slight buffeting, which does not impede flight control.	In the transonic speed range, airflow separation due to local impulses of increased load on the wing produces high frequency instability.	Manage airspeed and anticipate uncommanded high speed rolling tendency.
31.	Exceeding permissible loads may lead to subsequent uncommanded roll and slight pitching down tendencies.	Accumulating loads on the airframe lead to deformations of the wing structure.	Once deformation has occurred, flight control will not be significantly impacted, however attainable G loads will be reduced.

	<b>MODEL FEATURE</b>	<b>CAUSE</b>	<b>NOTE</b>
32.	Approaching minimum airspeed in level flight or maximum G load is accompanied by "warning" buffeting.	Uneven airflow separation occurs along the wingtips.	Continuing to reduce airspeed or increase G load will lead to a stall and possible subsequent spin. To prevent this, increase engine power if in level flight or reduce G load (reduce stick pull) if pulling G.
33.	When firing guns (any), long bursts of over 3 seconds may lead to a jam. Jamming probability is implemented as described by documented statistics.	Loading system overheating.	It is recommended to conduct fire in short bursts and at short ranges. A failed (jammed) gun is indicated by the extinguishing of the red "ready" light provided for each gun system on the instrument panel. To resolve the jam, press and hold the corresponding gun charging switch for at least 3 seconds to recharge the gun.
34.	When carrying external fuel tanks, the effects of their weight on the wings is accounted for in the model.	External tanks, especially when full, unload the wing during G loading. As such, carrying fuel tanks may actually work to alleviate the damaging effects of exceeding permissible G loads.	Exceeding 5 G with external tanks is prohibited, as subsequently they may fail to release due to stress damage.
35.	Exceeding maximum speeds when carrying external tanks produces buffeting and uncommanded roll.	Significant longitudinal forces (drag) acting on the tanks at high speeds produce torque effects on the wing structure, resulting in asymmetric deformations, which in turn lead to rolling tendencies.	As with normal high speed uncommanded roll, reduce airspeed by reducing engine power or extending the air brakes.

	<b>MODEL FEATURE</b>	<b>CAUSE</b>	<b>NOTE</b>
36.	If permissible G loads are exceeded with external tanks loaded, one or both tanks may not release.	Excessive G loads may damage the tank pylon locks and prevent release.	If one tanks fails to release, flight stability will be affected (increased roll, sideslip). It is recommended to exit the combat area and perform a landing with increased attention to avoid loss of control.
37.	The SPECIAL options page of the MiG-15bis module includes an option to show current G in the upper-right corner of the display.	No G indication is provided in the MiG-15bis cockpit.	
38.	The SPECIAL options page of the MiG-15bis module includes an option to display a special "guncam" window in the bottom-right corner of the display when guns are fired (in-mission or only during track playback).	Gameplay feature	The guncam window models the appearance of era guncam footage and appears on screen whenever any of the gun triggers are pressed.
39.	The SPECIAL options page of the MiG-15bis module includes an "AI helper" option, which uses image and text pop-ups during the mission to remind the player about critical cockpit configuration steps that have been missed.	Designed to ease new players into the simulation and lower the entry bar. Missing critical configuration steps may prevent the player from flying at all or make it difficult to operate certain systems, or lead to flight failure due to loss of consciousness of the virtual pilot.	Consists of graphical pop-ups including images of the corresponding cockpit elements and short directions in text format.

# 12

## EMERGENCY PROCEDURES



## 12. EMERGENCY PROCEDURES

### COMRADE PILOT!

Soviet people and their armed forces have entrusted you with a formidable weapon – the advanced MiG-15bis aircraft. Having this aircraft at your fingertips, knowing fully well its capabilities and particular qualities, you will honorably perform your sacred duty to protect your Socialist Motherland.

The aircraft at your disposal is reliable and subject to your will. If it is well prepared for a flight and you handle it perfectly, you can be absolutely sure that you will perform every flight task accurately and in due time.

However, if there is carelessness in the course of flight preparation or you do something wrong while in the cockpit, failures may occur in operation of systems or units of the aircraft.

First of all, remember:

1. Report aircraft failures to ATC (not used in the simulation).
2. If possible, use the speed margin for climbing. Avoid a speed lower than the handling speed (300 km/h).
3. If you have tried everything to recover the aircraft after a failure and you have made the decision to perform a belly landing, you should land on ground only. Landing on a concrete or metal runway may lead to fire on the aircraft and accidents.
4. When an instant danger to your life occurs while airborne, you are obliged to eject.

### ***12.1. Emergency procedures***

Remember the specific features of each possible failure of the aircraft and the corresponding countermeasures.

#### **12.1.1. Engine failure in flight**

Engine failure in flight may occur due to multiple reasons:

- errors in engine control: multiple abrupt throttle displacements from idle to full throttle and back (with a rate of less than 1.5 s), incorrect

usage of the isolation valve depending on engine operation mode and flight altitude;

- when the engine is in combat mode at airspeeds less than 300 km/h IAS
- failures in the engine fuel equipment.

You can learn that the engine has stopped by a sudden drop of RPM, fuel pressure and gas temperature and by a decrease in airspeed.

Once verified that the engine really has stopped, close the shut-off valve, fix the throttle to the idle detent and glide down towards an airfield or an area selected for landing. Avoid an airspeed lower than the "handling speed".

Switch off all circuit breakers on the right panel except for the battery, generator, radio, IFF transponder, elevator and aileron trim tabs. On the left panel do not switch off: "booster pump", "activation panel", "ignition, primer pump, solenoids of injection nozzles", "engine instruments", "annunciators of generators and external fuel tanks".

Additionally, in bad weather flights a horizon indicator-compass must be switched on. If your altitude is less than 2000 m, do not attempt an engine restart, land on the airfield with the landing gear down or perform a belly landing on a suitable area. If this is not possible, bail out.

If flying in the stratosphere, descend as soon as possible to an altitude of 11,000-10,000 m.

**Note.** You have a better chance of restarting a hot engine. Therefore, if the situation permits, descend as soon as possible to an altitude of 6000 m. Here, proper allowance must be made for an altitude margin to glide to the home or an alternate aerodrome.

Inside clouds, descend in a straight line only. If you break through the clouds at an altitude of more than 2000 m, you can attempt to restart the engine, if you are still in clouds down to this altitude, bail out.

### **12.1.2. Engine air restart**

Bear in mind that you have a better chance of restarting an engine with a decrease in altitude and airspeed.

Do not attempt to restart an engine at an altitude of more than 6000 m. Before restarting it, obtain a speed of 300-320 km/h.

The engine will certainly restart, if your actions are accurate and consistent. Set the switch to the "air ignition" position (simultaneously, a red light should light up) and open the shut-off valve in 10-15 s.

If the engine won't start, smoothly move the throttle (with a rate of 15 s) forward, then backward, to provide the optimal engine restart conditions.

When the RPM start to increase, deflect the throttle to the idle detent and monitor the gas temperature.

Switch off the air ignition switch – the red light will go out.

Set the required engine operation mode and switch on the circuit breakers that were switched off earlier.

**Note.** Before switching off the start ignition, setting the engine to an operation mode (cruise, etc.) is prohibited.

If the engine won't start in 40-45 s, close the shut-off valve and switch on the "air ignition"; check if the throttle is on the idle detent.

Restart the engine at a lower altitude, but not earlier than 20-30 s after closing the shut-off valve.

If the engine won't start before an altitude of 2000 m, stop further restart attempts and bail out if there is no suitable area for landing or if it is impossible to land on your aerodrome at night.

In case of engine shutdown while orbiting, quickly consider your chances of landing at an aerodrome or a previously explored area near the aerodrome. Bail out if you have doubts about being able to perform a safe landing.

### **12.1.3. Fuel pressure drop**

Cue: the "Priming Pressure" warning light is on. Check if the priming pump circuit breaker is on. If the priming pump is off, switch it on at any engine operation mode if you fly at an altitude lower than 9000 m. If you fly higher than that, first set RPM to 10,000 and then switch on the priming pump.

If the fuel pressure warning light is on, fly at altitudes lower than 9000 m.

### **12.1.4. Engine RPM drop**

If the engine RPM drop during the takeoff run, abort takeoff and take measures to stop your aircraft as soon as possible.

If the RPM drop in flight at an altitude less than 3000 m, switch on the isolation valve at any engine operation mode. At altitudes over 3000 m, switch on the isolation valve, only after having set the throttle to the idle detent. When the isolation valve is switched on, set the required RPM by moving the throttle smoothly and slowly.

Abort the mission and land at the home or alternate aerodrome.

You should switch off the isolation valve only after landing.

### **12.1.5. Engine stall**

Signs (possible manifestation of one or more issues at the same time): engine RPM hang (reduction), RPM unresponsiveness to throttle movements, engine overheat.

Actions: move throttle to idle until normal temperature and RPM values are reached (possible before the stable RPM reduction to idle position). Move throttle smoothly after.

### **12.1.6. Engine fire**

Cues of a fire in the vicinity of the engine are as follows:

- illumination of the engine fire warning light on the left side;
- a band of smoke, which is easy to see when turning around.

To stop a fire you need to:

- set the throttle to the idle detent;
- close the shut-off valve, switch off the fuel booster pump and fuel transfer pump;
- press the fire button;
- reduce the airspeed to 300-350 km/h using the excess speed to climb.

If smoke penetrates the cockpit, close the diluter valve on the oxygen regulator, reduce flight altitude to 7000 m, smoothly depressurize the cockpit and switch on the ventilation.

If the smoke doesn't disappear, release the canopy.

When the fire is stopped, do not attempt to start the engine. Decide whether to land with the engine dead or bail out.



### **12.1.7. Cockpit fogging (WIP)**

Check:

- if the canopy is pressurized;
- if the cockpit air supply valve is open.

Set the air supply valve to HOT, increase engine RPM and reduce the rate of descent.

### **12.1.8. Aircraft oxygen supply system failure**

Cues:

- indicator segments are dead or react weakly;
- pressure in the system has dropped abruptly (according to the air pressure gauge).

Actions:

- reduce flight altitude as soon as possible and abort the mission.

### **12.1.9. Cockpit decompression in stratosphere**

If cockpit decompression has occurred due to reasons not related to canopy glass destruction or canopy loss, switch on the emergency oxygen supply, reduce the flight altitude and abort the mission.

In case of canopy glass destruction or canopy loss, immediately reduce flight altitude and airspeed. Abort the mission.

### **12.1.10. Failure of aileron power unit (lateral control hydraulic system)**

You will notice a failure of the aileron power unit immediately by the strong efforts (implemented in the simulation as slowing down of the control stick movement) needed to move the control stick, by jerks of the control stick and by a pressure drop in the hydraulic boost system (lateral control hydraulic system).

If the aileron power unit fails, switch it off using the lever. Reduce the airspeed. Level flight and landing with the aileron power unit switched off are safe. Just

be especially careful in aircraft piloting and remember that greater efforts have to be applied on the control stick.

Maneuvering when the aileron power unit is switched off is forbidden.

Do not attempt to switch on the aileron power unit that failed, because you may lose control of the aircraft.

### **12.1.11. Generator failure**

Generator failure can be noticed by illumination of the red light and by ammeter readings. The ammeter indicator needle will show discharging.

If the generator has failed while flying in clouds or at night at an altitude less than 9000 m, the following equipment should remain switched on: radio, compass, horizon indicator, engine instruments, pitot heat, ultraviolet lights and aeronautical lights. If necessary, switch on the radio-compass and transmitter momentarily.

Do not switch off the fuel booster pump when flying higher than 9000 m.

Abort the mission.

Remember that the capacity of the onboard battery is sufficient for a flight in clouds for 24-26 min at daytime, and for 20-23 min at nighttime. If all the aircraft equipment is switched on, the battery will only operate for 10-14 min.

### **12.1.12. Radio communication failure**

In all cases of sudden radio blackout, check the junction of the connector for the earphone headset cord (not required in the simulation).

In case of radio communication failure under clouds, do not enter the clouds, abort the mission and land.

In case of radio failure in or above clouds, tune in to the aerodrome homing station and be extremely careful when carrying out the landing approach.

Take measures to avoid a collision while entering the clouds.

**Note.** If a homing station is additionally equipped, ATC commands can also be received via the ADF receiver (not implemented in DCSW). To do this, set the АРК-ПРИЕМ (ARK-RECEIVE) switch to the АРК (ARK) position. Set the ARK-5 mode selector switch on the ADF control panel to the АНТ. (ANT., ANTENNA) position and set the ТЛГ-ТЛФ (TLG-TLF) receiver mode switch to the ТЛФ (TLF, telephony) position. After receiving ATC commands, you can set the mode selector switch back. Otherwise, the directional indicator will not show the direction to the homing station.

### **12.1.13. Aircraft lighting facilities failure at night**

If the external lights fail, be more careful during aerodrome approach, report on your location, and if the floodlight is operational, switch it on from time to time to show your location. The floodlight can be used at airspeeds up to 400 km/h IAS.

If the UV-lights fail, use the white cockpit lights to illuminate the instruments.

#### ***Flight navigation instrument failure in bad weather***

### **12.1.14. Attitude indicator failure**

A failure of the attitude indicator can be detected by comparing its readings with those of the turn indicator, distance-reading gyromagnetic compass, climb indicator and the airspeed indicator. If a failure of the attitude indicator is ascertained:

- pilot the aircraft using the turn and slip indicator combined with the airspeed indicator, climb indicator, altimeter and distance-reading gyromagnetic compass;
- maintain the flight mode in lateral attitude in accordance with the turn and slip indicator; in longitudinal attitude in accordance with the airspeed indicator, altimeter and climb indicator; in directional attitude in accordance with the turn indicator checked by compass and ADF.

If the attitude indicator fails when ascending through clouds, fly the aircraft as described above and break through the clouds.

Above the clouds roll into final, maintain the airspeed, extend the landing gear and set the flaps into takeoff position.

Descend through the clouds with the assigned vertical speed and heading. While in the clouds, do not correct an error within 10°-20° of the landing approach. Take all due measures to get on the outer beacon.

If necessary, visually correct the landing approach.

### **12.1.15. Speed indicator, altimeter and climb indicator failure**

- check if the pitot heat is switched on;

- maintain the flight mode by observing the attitude indicator combined with the turn and slip indicator, and the engine RPM indicator. Determine the altitude by the RV-2 radar altimeter.

#### **12.1.16. Automatic direction finder (ADF) failure**

When the ADF fails while flying to an aerodrome homing beacon, maintain the flight mode by using the gyromagnetic compass to enter the aerodrome traffic area. From time to time, verify the accuracy of the course by requesting a course to the beacon from ATC.

If the ADF fails inside or above clouds, perform the landing approach with the gyromagnetic compass, combined with the beacon course and ATC commands.

#### **12.1.17. Gyromagnetic compass failure**

- enter the aerodrome using the radio-compass, magnetic compass (KI-11) and ATC commands (not implement yet);
- in instrument meteorological conditions (IMC) perform the landing approach using the ADF, combined with the ground radio direction finder and ATC commands.

#### **12.1.18. Emergency landing gear and flaps extension**

If it is impossible to extend the landing gear as usual, use the following emergency extension procedure:

- set the landing gear lever into the neutral position;
- pull the right landing gear emergency extension handle (to manually open the gear locks of the nose and right landing gear);
- pull the left landing gear emergency extension handle (to manually open the gear locks of the left landing gear);
- verify that the gear legs have unlocked: the indicator lights will go out and the mechanical indicators will somewhat come out;
- set the landing gear lever to the ВЫПУЩЕНО (RELEASED) position;
- open the emergency landing gear extension valve by rotating the handle on the right-hand panel.

Verify successful landing gear extension by the mechanical indicators and illumination of the green indicator lights.

**Remember!** It is forbidden to retract the landing gear after its emergency extension in flight.

For emergency flap extension, set the flap lever into the full down position: ВыП. 55° (EXTEND 55°); open the emergency flaps extension valve on the right-hand panel. Verify successful flap extension by illumination of the green 55° flaps extension angle signal lamp on the left instrument panel and the mechanical indicator on the left wing.

If, for some reason, the air pressure in the emergency pneumatic system is insufficient, while there is still some air in the main pneumatic system, bleed off the air from the main system into the emergency system by opening the emergency air tank charging valve, which is located on the right side of the cockpit.

#### **12.1.19. Landing when the nose gear leg is not extended**

If the nose gear leg is not extended and it is impossible to retract the main landing gear, land on a concrete or unpaved runway.

**It is forbidden** to land on a metal runway if the nose gear leg is not extended.

When a landing gear is not fully down, take measures to retract it and perform a belly landing, but only on unpaved strips.

#### **12.1.20. Forced landing**

In case of a forced landing, perform a belly landing with flaps extended only. At an altitude equal to or less than 100 m, open the canopy and switch off the battery. Maintain a gliding speed of 260-270 km/h.

In case of a landing with a working engine, after having ensured that the predicted trajectory is correct, switch the engine off.



**13**

**HOW TO PLAY**

## 13. HOW TO PLAY

[To Important notice](#)

### **13.1. General information**

This game is a first-person aircraft simulation, where the player controls an airplane and interacts with cockpit objects with the help of various game controllers (joysticks, pedals, touchpads, etc.), keyboard and mouse.

It is possible to set an external camera (relative to the airplane's cockpit) in any place of the game world to observe the player's airplane and other objects in the world.

The simulation gives the player the unique opportunity to control an airplane in real-time in the same way a real pilot does. The player has to interact with cockpit objects, distribute his/her attention between the cockpit and the outside world at every stage of the flight – from engine startup to taxiing to the parking spot after landing. In addition, there are scenarios where the player has to interact with and give orders to wingmen (player's squadron pilots).

The game can be played in single-player mode (the player is alone in the simulated world, everything else is controlled by the AI) or in multiplayer mode (there are several human players connected via the internet, other objects are controlled by the AI).

When a module is purchased, it has to be installed and activated as a module to DCS World. The main documents, describing the activation procedure, the main window functions, game settings, mission editor, and the setup of game controllers are located in the "Doc" folder inside the game installation directory. Each document describes a certain game functionality:

- a) how to install and activate the game
- b) [DCS World Activation Guide EN.pdf](#);
- c) the main game window and mission editor functionality
- d) [DCS User Manual EN.pdf](#);
- e) setup of game controllers
- f) [DCS World Input Controller Walk Through EN.pdf](#);
- g) Airfields radio equipment and beacons
- h) [DCS World List of all available Beacons EN.pdf](#).

For a player to find himself in the cockpit it is necessary to start relevant mission (scenario) under control of the DCS World shell. Missions can be built-in in the game (supplied with the module installation package), downloaded from the internet or developed independently. A set of related missions is called a campaign. The user can create a mission (campaign) by himself, using the MISSION EDITOR (ME) tools. Usage of the mission editor is described in the document [DCS User Manual EN.pdf](#)

### ***Interaction between player and virtual cockpit***

Inside the cockpit, the player can **control the aircraft, cockpit objects** and **virtual pilot head position** (views). All these functions can be implemented by means of keyboard only, mouse, joystick or by their various combinations. It is recommended to use a joystick for controlling the aircraft for the best possible game experience.

The mouse can be used in the following two modes:

- control various objects in the clickable cockpit;
- control virtual pilot head position (view control, "mouse view").

The player can switch between these two modes at any time by pressing the keyboard combination **|LAlt + C|** or by a double-click of the mouse wheel.

## ***13.2. Built-in missions***

The game comes with a set of built-in missions: training missions, ordinary missions and a campaign. Non-training missions (e.g. campaign) usually assume that the player is already familiar with the airplane and willing to try a scenario on his own.

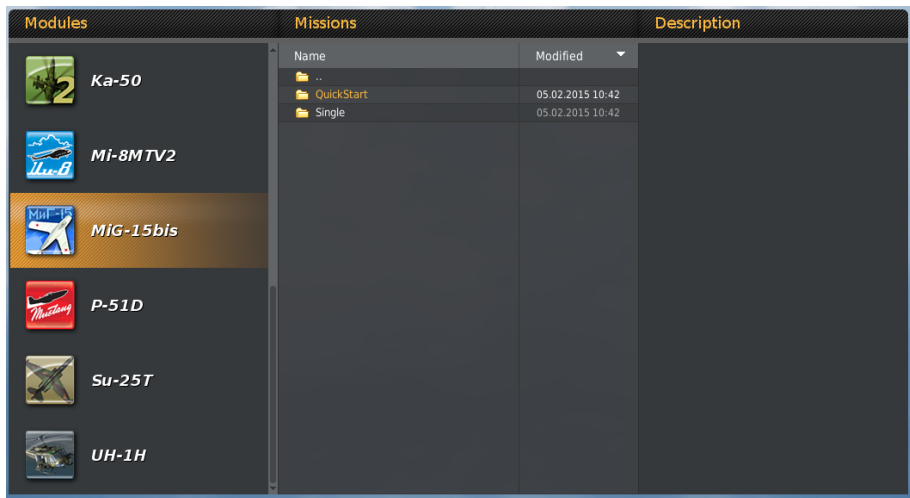
### ***Procedure for built-in mission start:***

1. Start DCS World. When in the main menu, one can either start a training mission by selecting TRAINING or ordinary missions by selecting INSTANT ACTION or MISSION.



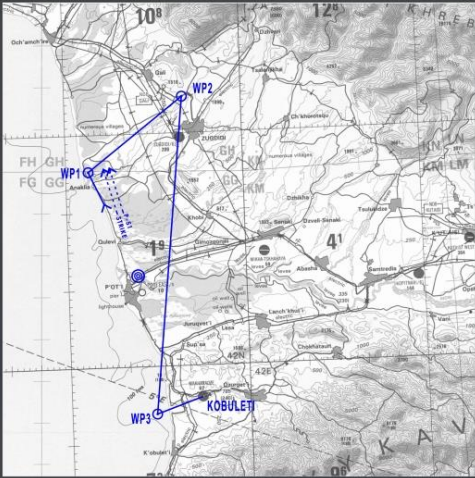


2. To choose a mission, it is necessary to select the desired module on the left and then pick a mission from the corresponding folder (the example below contains the folders "QuickStart" and "Single"):



3. When the mission is selected, a briefing window with a START button, which is used to start the mission, appears on the screen:

Details



**MISSION OVERVIEW**

Title Flight Suit Attitude  
Start at 15/9/2011 09:36:00  
My Side USA  
Allies Australia - Belgium - Canada - Denmark - France - Georgia - Germany - Israel - Italy - Norway - Spain - The Netherlands - Turkey - UK - USA  
Enemies Abkhazia - Russia - South Ossetia - Ukraine

**MISSION DATA**

My task Fighter Sweep  
Flight F-86F\*4  
Fuel 692(0)  
Weapon \*Fuel Tank 120 gallons\*2

**ALLIES FLIGHT**


Allies flight \*P-51D\*\*4

**SITUATION**

September 15th, 1952

Take the role of Robinson Risner as you lead an escort mission for a Mustang ground attack strike. Orbit the Mustang flight as it attacks ground targets and protect it from MiGs.

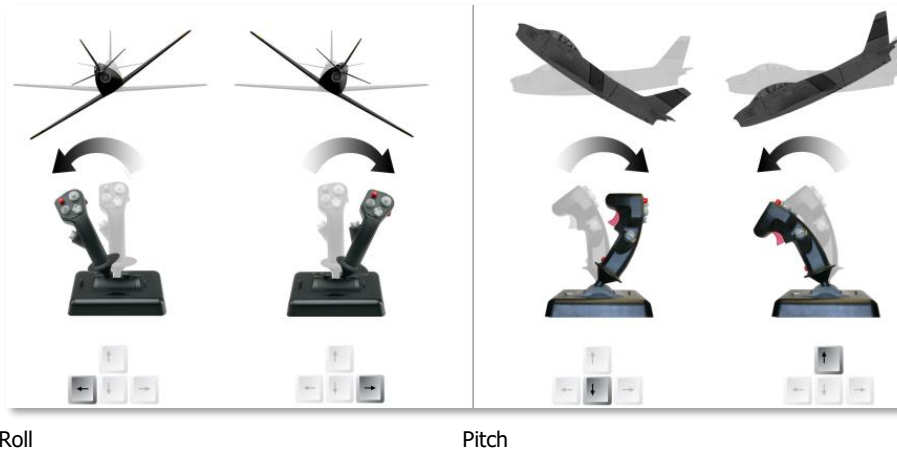
Mid-way through their top cover, the flight runs into a flight



### 13.3. Controlling airplane and various cockpit objects

The airplane is controlled by means of the control stick, throttle and pedals. The stick is used to control roll (rotation around the axis running from the nose to the tail) while turning the airplane and pitch (nose up or down around the axis running from wing to wing) thus creating dive and climb moments. The throttle handle is used to control engine power (thrust) when necessary to increase or decrease translational speed. The pedals are used to control yaw (nose left or right around the axis running up and down) and to compensate sliding. Besides that, they are used to control wheel brakes separately while taxiing (simultaneously with rudder).

### 13.3.1. Controlling airplane with joystick



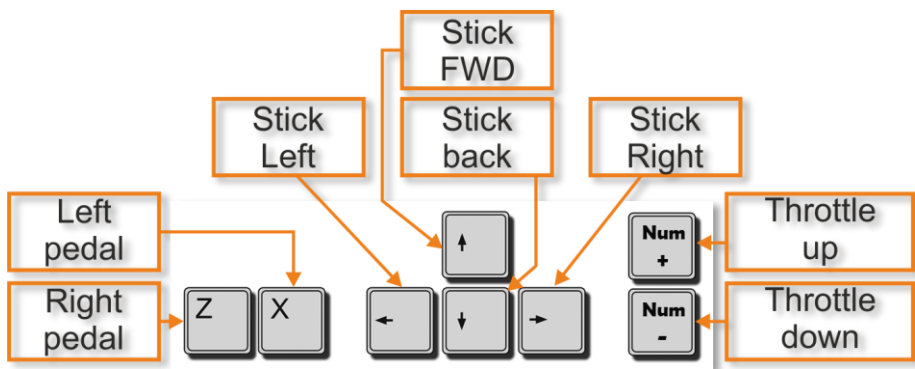
The joystick can be equipped with a throttle handle or a rotating knob (can be any of joystick's axis), which control engine power and with twist (for controlling pedals).

It is possible to enable [a controls indicator](#) using the keyboard combination **|RCtrl + Enter|** to check the individual positions of the cockpit controls



### 13.3.2. Controlling airplane with keyboard

If the player controls the airplane using only the keyboard, the main control buttons are: arrow keys to control roll and pitch, **|Numpad+|** or **|Numpad-|** for thrust control and **|Z|** or **|X|** keys for pedals.



### 13.3.3. Interacting with cabin objects with the mouse

All objects of the clickable cockpit can be controlled by the mouse. This is the main mouse mode in the game. The left and right buttons and the mouse wheel can be used.

Normally, all switches are enabled by the left mouse button. The rotary switches (rotating knobs with fixed positions) rotate with the left mouse button in one direction and with the right one in the other. Cockpit objects, which can be enabled or disabled with the mouse (when the mouse pointer is over them), are marked with the following symbol:



Rotating knobs can be rotated with the mouse wheel. The cockpit objects, which can be rotated when the mouse pointer is over them, are marked with the following symbol:



To speed up the rotation of the knobs using the mouse wheel, it is necessary to press **|LShift|** while rotating the mouse wheel. This way the knob will rotate 10 times faster. By default, the mouse is in the "cockpit object control mode" described above.

## 13.4. Controlling virtual pilot head position and views in the 6DOF cockpit

### 13.4.1. Controlling virtual pilot head position in the 6DOF cockpit

This implies that the head can be moved along the three axes (OX, OY, OZ), and rotated around these axes (Figure 13.1).

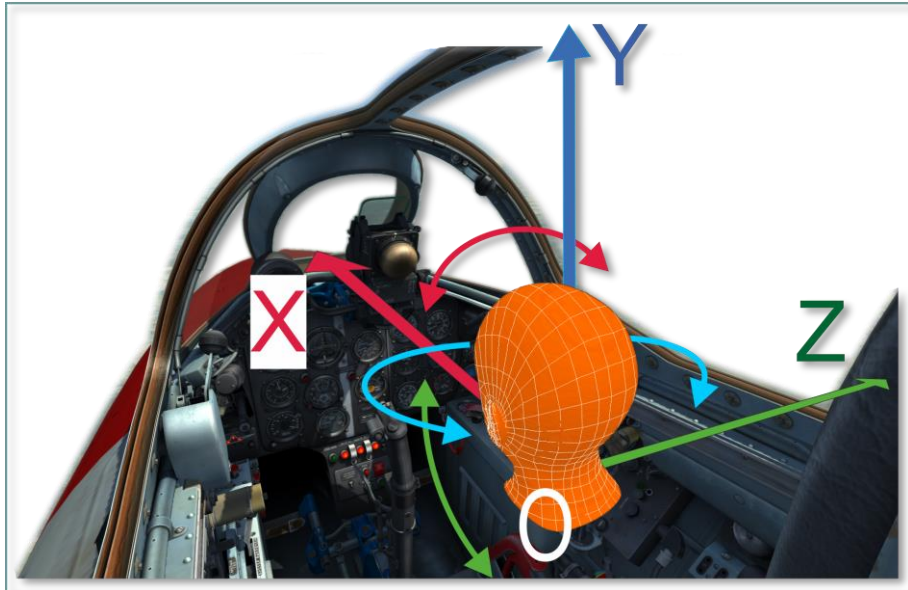


Figure 13.1. Axes in the 6DOF cockpit

Head position may be controlled by all input devices: keyboard, mouse, joystick and head tracking devices such as TrackIR. Note that virtual head rotation around the OX axis (red color curved arrow) usually is not used, that is why it is unavailable for controlling by means of keyboard and mouse.

In addition to head movement and rotation, there is also zoom feature (cockpit view angle reduction).






I.e. the working area of the screen displays only objects, which is inside the field of view. Because the field of view becomes narrow during zooming, objects within the same area become larger. This can be compared with the use of a telescope: all objects, located along the line of sight, are visible at any magnification.

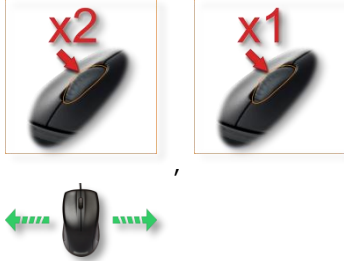
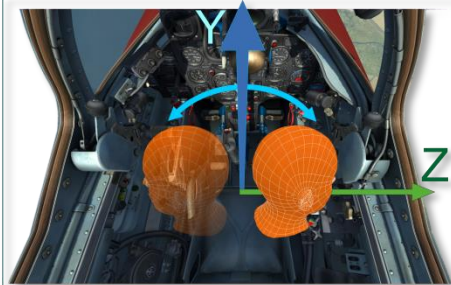

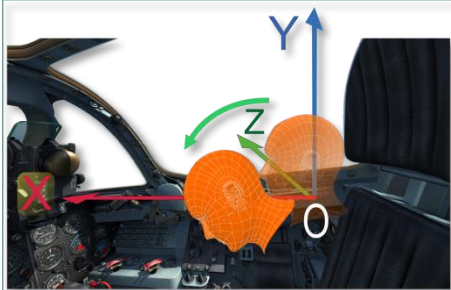

### Head movement, rotation and image zooming with keyboard and mouse

Symbols on schematics showing the mouse usage:

	Click and hold the wheel pressed
	Wheel double click
	Click, hold the wheel pressed and rotate it
	Rotate mouse wheel
	Head movement along the corresponding axis
	Head rotation around the corresponding axis

By default, the mouse is in *COCKPIT OBJECT CONTROL MODE*. To switch it in *VIRTUAL PILOT HEAD POSITION CONTROL MODE* (and back), it is necessary to use the key combination **|LAlt+C|** or **perform a double click of the mouse wheel**.

Action	Implementation by keyboard and mouse
	<p>Implementation by keyboard and mouse</p> <p>With keyboard:  RCtrl + RShift + *  or  RCtrl + RShift + / </p> <p>With mouse:</p>  
	<p>With keyboard:  RCtrl + RShift + Num2  or  RCtrl + RShift + Num8 </p> <p>With mouse:</p>   <p>and</p> 
	<p>With keyboard:  RCtrl + RShift + Num4  or  RCtrl + RShift + Num6 </p> <p>With mouse:</p>

	 <p>and</p>
	<p>With keyboard:  Num4  or  Num6 </p> <p>With mouse:</p> 
	<p>With keyboard:  Num2  or  Num8 </p> <p>With mouse:</p> 





### 13.4.2. Controlling views in the 6DOF cockpit

Many cockpit objects are located inconveniently (in niches, covered by other objects). To be able to quickly look at the correct object in flight and return to the instrument panel, the built-in **SnapView** function can be used using key combinations. This function "remembers" custom views created by the player and allocates corresponding key combinations on the numeric keyboard. After recording, they can be used with the key combination |Num0 (modifier) + Num1...9 (one of 9 needed views)|.

Before creating individual custom views, the player is encouraged to review the pre-defined default views by pressing |Num0 + Num1...9| in succession. In many cases, the default views are sufficient for the player's needs.

To create a custom SnapView, it is necessary to:

- a) activate saving of one of the views by pressing |Num0 + Num1...9| (only one number), start of the saving is activated;
- b) set up the view as needed. View adjustments can be done with standard keyboard commands for controlling the camera:
  - |Num\*| – zoom in slow

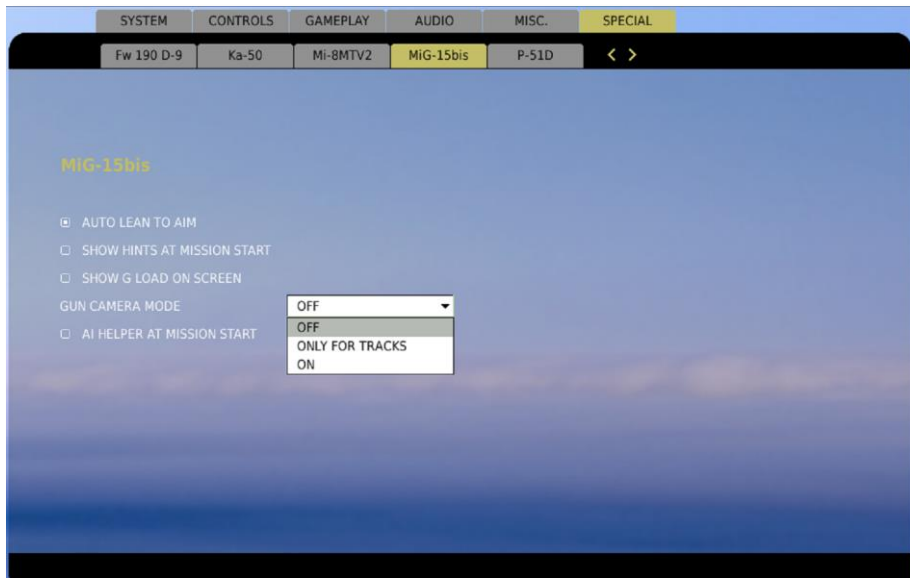
- |Num/| – zoom out slow
  - |RShift + RCtrl + Num2| – cockpit camera move down
  - |RShift + RCtrl + Num8| – cockpit camera move up
  - |RShift + RCtrl + Num4| – cockpit camera move left
  - |RShift + RCtrl + Num6| – cockpit camera move right
  - |Num1...9| – rotation of the current point of view  
(|Num5| – center view)
  - |RShift + RCtrl + Num\*| – cockpit camera move forward
  - |RShift + RCtrl + Num/| – cockpit camera move back
- (1) move the camera to the center of the selected object  
|RShift + RCtrl + Num2,8,6,4|;
  - (2) turn the sight axis to the desired angle |Num2,8,6,4|;
  - (3) zoom to the object at the desired distance: zoom in |\*| or zoom out |/|;
- c) finish storing the adjusted views to a file by pressing the key combination |RAlt + Num0 + Num1..9|.

Information about custom views is stored in the file

"C:\Users\<<USERNAME>\Saved Games\DCS\Config\View\SnapViews.lua".

### ***13.5. Special game settings***

Special game settings are located on the following tab, see the example below.



AUTO LEAN TO AIM – pilot's head is automatically lifted to the center line of gunsight;  
 SHOW HINTS AT MISSION START – show hints at mission start;

SHOW G LOAD ON SCREEN – show the G-factor in the upper right screen corner;  
 GUN CAMERA MODE – S-13 gun camera results display mode;  
 AI HELPER AT MISSION START – cockpit helper mode (see below).

## ***13.6. Informational help to the player***

To ease the learning process and also to compensate "flight in front of the monitor" inconveniences, "AI helper" and kneeboard are available in the game.

### **13.6.1. AI helper**

The AI helper was introduced to direct the player's attention to a mandatory action with cockpit equipment, if this action was not performed. A small figure is displayed, which is indicating the critical cockpit element (or which action should be performed outside the aircraft).

The following example of an active AI helper is alerting the player to open the air supply valve in order to seal the canopy:



This option is activated by checking the following checkbox in the game (module) settings:

AI HELPER AT MISSION START

### 13.6.2. Kneboard

The kneboard contains information about current conditions of the most important systems and key combinations to control these systems:

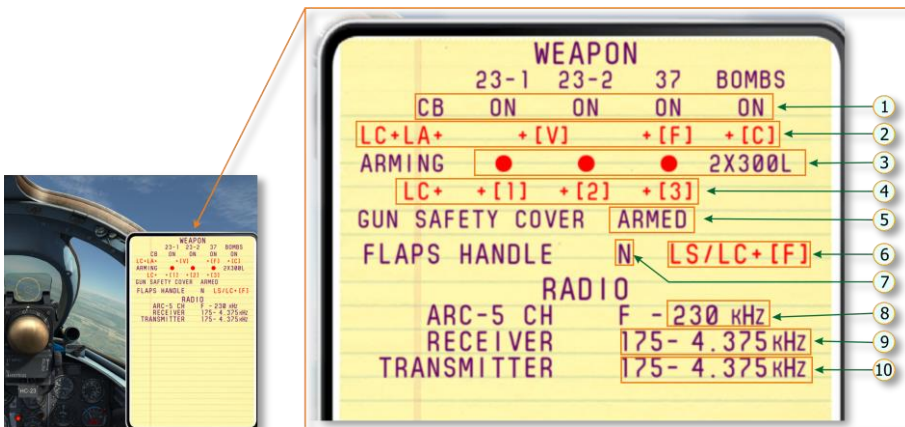


Figure 13.2. Kneboard informs player about conditions of the aircraft's important systems

1. Weapon ACBs state
2. Keyboard commands to turn on weapon ACBs (LC=LCtrl, LA=LAlt, LS=LShift)
3. Cannons reload condition (bombs or drop tanks presence)
4. Keyboard commands for cannon reloading
5. Gun safety cover position/state on the stick  
(now in the combat position)
6. Keyboard commands to move flaps lever
7. Current flaps position (N=neutral)
8. ARK-5 current frequency
9. RSI-6 receiver frequency settings
10. RSI-6 transmitter frequency settings

The kneboard is activated by pressing **|K|** (shown only while the key is kept pressed) or **|RShift + K|** (toggle mode, i.e. switched on/off by the same key combination).



**14**

**ABBREVIATIONS  
AND TERMS**

## 14. ABBREVIATIONS AND TERMS

AC	Alternating Current	DIS	Disable
ACB	Automatic Circuit Breaker	DISP	Dispense
ADF	Automatic Direction Finder	DSCRM	Discriminator
AGL	Above Ground Level	ECM	Electronic Countermeasures
AI	Attack Imminent	EGT	Exhaust Gas Temperature
ALT	Alternator	ELEC	Electrical
ALT	Altitude/Altimeter	EMER	Emergency
ALTM	Altimeter	END	Endurance
AM	Amplitude Modulation	ENG	Engine
AMP	Ampere	ESS	Essential
ANT	Antenna	EXH	Exhaust
ATTD	Attitude	EXT	Extend
AUTO	Automatic	EXT	Exterior
AUX	Auxiliary	F	Fahrenheit
AVGAS	Aviation Gasoline	FAT	Free Air Temperature
BAT	Battery	FITG	Fitting
BDHI	Bearing Distance Heading Indicator	FCU	Fuel Control Unit
BFO	Beat Frequency Oscillator	FM	Frequency Modulation
BL	Butt Line	FOD	Foreign Object Damage
BRIL	Brilliance	FPS	Feet Per Second
BRT	Bright	FREQ	Frequency
C	Celsius	FS	Fuselage Station
CARR	Carrier	FT	Foot
CAS	Calibrated Airspeed	FT/MIN	Feet Per Minute
CCW	Counter Clockwise	FUS	Fuselage
CDI	Course Deviation Indicator	FWD	Forward
CG	Center of Gravity	$\Delta F$	Increment of Equivalent Flat Plate Drag Area
CL	Centerline	G	Gravity
CMPS	Compass	G	Guard
CNVTR	Converter	GAL	Gallon
COLL	Collision	GD	Guard
COMM	Communication	GEN	Generator
COMP	Compartment	GND	Ground
CONT	Control	GOV	Governor
CONT	Continuous	GPU	Ground Power Unit
CONV	Converter	GRWT	Gross Weight
CW	Clockwise	GW	Gross Weight
DC	Direct Current	HDG	Heading
DCP	Dispenser Control Panel	HF	High Frequency
DF	Direction Finding	HIT	Health Indicator Test
DECR	Decrease	HTR	Heater
DELTA A	Incremental Change	HYD	Hydraulic
DET	Detector	IAS	Indicated Airspeed
DG	Directional Gyro		

ICS	Interphone Control Station	INVTR	Inverter
IDENT	Identification	IR	Infrared
IFF	Identification Friend or Foe	IRT	Indicator Receiver Transmitter
IGE	In Ground Effect	ISA	International Standard Atmosphere
IN	Inch	KCAS	Knots Calibrated Airspeed
INCR	Increase	KHz	Kilohertz
IND	Indication/Indicator	KIAS	Knots Indicated Airspeed
INHG	Inches of Mercury	km	Kilometer
INOP	Inoperative	KTAS	Knots True Airspeed
INST	Instrument	KN	Knots
INT	Internal	kVA	Kilovolt-Ampere
INT	Interphone	kW	Kilowatt
INV	Inverter	L	Left
		LB	Pounds
		LDG	Landing
		LH	Left Hand
		LSB	Lower Sideband
		LT	Lights
		LTG	Lighting
		LTS	Lights
		MAG	Magnetic
		MAN	Manual
		MAX	Maximum
		MED	Medium
		MHF	Medium-High Frequency
		MHz	Megahertz
		MIC	Microphone
		MIN	Minimum
		MIN	Minute
		MISC	Miscellaneous
		mm	Millimeter
		MON	Monitor
		MWO	Modification Work Order
		NAV	Navigation
		NET	Network

NO	Number	SEC	Secure
NM	Nautical Mile	SEL	Select
NON-ESS	Non-Essential	SENS	Sensitivity
NON-SEC	Non-Secure	SL	Searchlight
NORM	Normal	SOL	Solenoid
NVG	Night Vision Goggles	SQ	Squelch
NR	Gas Turbine Speed	SSB	Single Sideband
N1	Gas Turbine Speed	STA	Station
N2	Power Turbine Speed	STBY	Standby



OGE	Out of Ground Effect	SQ FT	Square Feet
PED	Pedestal	TAS	True Airspeed
PLT	Pilot	TEMP	Temperature
PRESS	Pressure	TGT	Turbine Gas Temperature
PRGM	Program	T/R	Transmit-Receive
PSI	Pounds Per Square Inch	TRANS	Transfer
PVT	Private	TRANS	Transformer
PWR	Power	TRANS	Transmitter
QTY	Quantity	TRQ	Torque
%Q	Percent Torque	UHF	Ultra-High Frequency
R	Right	USB	Upper Sideband
RCVR	Receiver	VAC	Volts, Alternating Current
R/C	Rate of Climb	VDC	Volts, Direct Current
R/D	Rate of Descent	VHF	Very high Frequency
RDR	Radar	VM	Volt Meter
RDS	Rounds	VOL	Volume
REL	Release	VOR	VHF Omni Directional Range
REM	Remote	VNE	Velocity, Never Exceed (Airspeed Limitation)
RETR	Retract	WL	Water line
RETRAN	Retransmission	WPN	Weapon
RF	Radio Frequency	XCVR	Transceiver
RH	Right Hand	XMIT	Transmit
RI	Remote Height Indicator	XMTR	Transmitter
RPM	Revolutions Per Minute	XMSN	Transmission
SAM	Surface to Air Missile		
SEC	Secondary		

15

# THE METRIC SYSTEM AND EQUIVALENTS, CONVERSION FACTORS

**\*Equivalents**

1 in.	= 2.540 cm
1 ft.	= 30.48 cm
1 yd.	= 91.44 cm
1 mi.	= 1.609 km
1 km.	= 0.621 mi.
1 sq. ft.	= 0.093 sq. m.

**\*Settings**

1 opp. 2.31	sq. yd. = 8361 m <sup>2</sup>
1 opp. 89	sq. mi. = 2.60 km <sup>2</sup>
1 opp. 3740	cu. in. = 16.38 cm <sup>3</sup>
1 opp. 140	cu. ft. = 0.0283 m <sup>3</sup>
1 opp. 38	cu. yd. = 1.35 m <sup>3</sup>
1 opp. 200	cu. ft. = 62.43 liters
1 opp. 14	cu. ft. = 28.32 liters

**\*Equivalents**

1 lb.	= 453.6 gm.
1 oz.	= 28.35 gm.
1 ton	= 2048 kg.
1 gal.	= 3.785 liters
1 qt.	= 0.946 liters
1 pt.	= 0.473 liters
1 cup	= 0.237 liters

**\*Settings**

1 opp. 51	sq. ft. = 0.093 sq. m.
1 opp. 161	sq. yd. = 0.845 sq. m.
1 opp. 2.54	cm. = 0.0328 ft.
1 opp. 61	cm. = 0.0109 m.
1 opp. 1.83	cm. = 0.0183 m.
1 opp. 1.35	cm. = 0.0135 m.
1 opp. 1.35	cm. = 0.0135 m.
1 opp. 1.35	cm. = 0.0135 m.
1 opp. 1.35	cm. = 0.0135 m.

**\*Equivalents**

1 in.	= 2.540 cm
1 ft.	= 30.48 cm
1 yd.	= 91.44 cm
1 mi.	= 1.609 km
1 km.	= 0.621 mi.
1 sq. ft.	= 0.093 sq. m.

**\*Settings**

1 opp. 2.31	sq. yd. = 8361 m <sup>2</sup>
1 opp. 89	sq. mi. = 2.60 km <sup>2</sup>
1 opp. 3740	cu. in. = 16.38 cm <sup>3</sup>
1 opp. 140	cu. ft. = 0.0283 m <sup>3</sup>
1 opp. 38	cu. yd. = 1.35 m <sup>3</sup>
1 opp. 200	cu. ft. = 62.43 liters
1 opp. 14	cu. ft. = 28.32 liters

**\*Equivalents**

1 lb.	= 453.6 gm.
1 oz.	= 28.35 gm.
1 ton	= 2048 kg.
1 gal.	= 3.785 liters
1 qt.	= 0.946 liters
1 pt.	= 0.473 liters
1 cup	= 0.237 liters

**\*Settings**

1 opp. 51	sq. ft. = 0.093 sq. m.
1 opp. 161	sq. yd. = 0.845 sq. m.
1 opp. 2.54	cm. = 0.0328 ft.
1 opp. 61	cm. = 0.0109 m.
1 opp. 1.83	cm. = 0.0183 m.
1 opp. 1.35	cm. = 0.0135 m.
1 opp. 1.35	cm. = 0.0135 m.
1 opp. 1.35	cm. = 0.0135 m.
1 opp. 1.35	cm. = 0.0135 m.

**\*Equivalents**

1 in.	= 2.540 cm
1 ft.	= 30.48 cm
1 yd.	= 91.44 cm
1 mi.	= 1.609 km
1 km.	= 0.621 mi.
1 sq. ft.	= 0.093 sq. m.

**\*Settings**

1 opp. 2.31	sq. yd. = 8361 m <sup>2</sup>
1 opp. 89	sq. mi. = 2.60 km <sup>2</sup>
1 opp. 3740	cu. in. = 16.38 cm <sup>3</sup>
1 opp. 140	cu. ft. = 0.0283 m <sup>3</sup>
1 opp. 38	cu. yd. = 1.35 m <sup>3</sup>
1 opp. 200	cu. ft. = 62.43 liters
1 opp. 14	cu. ft. = 28.32 liters

**\*Equivalents**

1 lb.	= 453.6 gm.
1 oz.	= 28.35 gm.
1 ton	= 2048 kg.
1 gal.	= 3.785 liters
1 qt.	= 0.946 liters
1 pt.	= 0.473 liters
1 cup	= 0.237 liters

**\*Settings**

1 opp. 51	sq. ft. = 0.093 sq. m.
1 opp. 161	sq. yd. = 0.845 sq. m.
1 opp. 2.54	cm. = 0.0328 ft.
1 opp. 61	cm. = 0.0109 m.
1 opp. 1.83	cm. = 0.0183 m.
1 opp. 1.35	cm. = 0.0135 m.
1 opp. 1.35	cm. = 0.0135 m.
1 opp. 1.35	cm. = 0.0135 m.
1 opp. 1.35	cm. = 0.0135 m.

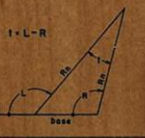


$\alpha =$  Bearing Angle  
Quad.  
I (N-E) :  $\alpha = A_2$   
II (N-W) :  $\alpha = 320 - A_2$   
III (S-W) :  $\alpha = A_2 - 320$   
IV (S-E) :  $\alpha = 640 - A_2$

$\sin \alpha = \frac{\Delta x}{\Delta r}$   
 $\cos \alpha = \frac{\Delta y}{\Delta r}$   
 $\tan \alpha = \frac{\Delta x}{\Delta y}$



$\tan L = \frac{PR \sin P}{LP - PR \cos P}$



$\frac{a}{\sin A} = \frac{b}{\sin B} = \frac{c}{\sin C}$   
 $C = A - B$   
 $b = \frac{a \sin B}{\sin C}$   
 $a = \frac{b \sin A}{\sin C}$   
 $c = \frac{a \sin A}{\sin C}$   
C = base  
C = Apex Angle  
A or B = Opposite Angle  
a or b = Range



Low of sines:  
 $\frac{a}{\sin A} = \frac{b}{\sin B} = \frac{c}{\sin C}$   
Low of cosines:  
 $a^2 = b^2 + c^2 - 2bc \cos A$



Low of sines:  
 $\frac{a}{\sin A} = \frac{b}{\sin B} = \frac{c}{\sin C}$   
Low of cosines:  
 $a^2 = b^2 + c^2 - 2bc \cos A$

## 15. THE METRIC SYSTEM AND EQUIVALENTS, CONVERSION FACTORS

### 15.1.1. The Metric System and Equivalents

#### Linear Measure

1 centimeter = 10 millimeters = .39 inch  
1 decimeter = 10 centimeters = 3.94 inches  
1 meter = 10 decimeters = 39.37 inches  
1 dekameter = 10 meters = 32.8 feet  
1 hectometer = 10 dekameters = 328.08 feet  
1 kilometer = 10 hectometers = 3,280.8 feet

#### Weights

1 centigram = 10 milligrams = .15 grain  
1 decigram = 10 centigrams = 1.54 grains  
1 gram = 10 decigram = .035 ounce  
1 decagram = 10 grams = .35 ounce  
1 hectogram = 10 decagrams = 3.52 ounces  
1 kilogram = 10 hectograms = 2.2 pounds  
1 quintal = 100 kilograms = 220.46 pounds  
1 metric ton = 10 quintals = 1.1 short tons

#### Liquid Measure

1 centiliter = 10 milliliters = .34 fl. ounce  
1 deciliter = 10 centiliters = 3.38 fl. ounces  
1 liter = 10 deciliters = 33.81 fl. ounces  
1 dekaliter = 10 liters = 2.64 gallons  
1 hectoliter = 10 dekaliters = 26.42 gallons  
1 kiloliter = 10 hectoliters = 264.18 gallons

#### Square Measure

1 sq. centimeter = 100 sq. millimeters = .155 sq. inch  
1 sq. decimeter = 100 sq. centimeters = 15.5 sq. inches  
1 sq. meter (centare) = 100 sq. decimeters = 10.76 sq. feet  
1 sq. dekameter (are) = 100 sq. meters = 1,076.4 sq. feet  
1 sq. hectometer (hectare) = 100 sq. dekameters = 2.47 acres  
1 sq. kilometer = 100 sq. hectometers = .386 sq. mile

#### Cubic Measure

1 cu. centimeter = 1000 cu. millimeters = .06 cu. inch  
1 cu. decimeter = 1000 cu. centimeters = 61.02 cu. inches  
1 cu. meter = 1000 cu. decimeters = 35.31 cu. feet

### 15.1.2. Approximate Conversion Factors

To change (imperial)	To (metric)	Multiply by
inches	centimeters	2.540
feet	meters	.305
yards	meters	.914
miles	kilometers	1.609
knots	km/h	1.852
square inches	square centimeters	6.451
square feet	square meters	.093
square yards	square meters	.836
square miles	square kilometers	2.590
acres	square hectometers	.405
cubic feet	cubic meters	.028
cubic yards	cubic meters	.765
fluid ounces	milliliters	29,573
pints	liters	.473
quarts	liters	.946
gallons	liters	3.785
ounces	grams	28.349
pounds	kilograms	.454
short tons	metric tons	.907
pound-feet	Newton-meters	1.356
pound-inches	Newton-meters	.11296
ounce-inches	Newton-meters	.007062
(metric)	(imperial)	
centimeters	inches	.394
meters	feet	3.280
meters	yards	1.094
kilometers	miles	.621
km/h	knots	0.54
square centimeters	square inches	.155
square meters	square feet	10.764
square meters	square yards	1.196
square kilometers	square miles	.386
square hectometers	acres	2.471
cubic meters	cubic feet	35.315
cubic meters	cubic yards	1.308
milliliters	fluid ounces	.034
liters	pints	2.113
liters	quarts	1.057

liters	gallons	.264
grams	ounces	.035
kilograms	pounds	2.205
metric tons	short tons	1.102



"Enchant by realism!"

belsimtek



16

DEVELOPERS

## 16. DEVELOPERS

### BELSIMTEK

#### MANAGEMENT

Alexander Podvoyskiy  
Alexander "Foxhound"

Project and QA Manager,  
technical documentation  
Module project manager

#### PROGRAMMERS

Vladimir "cofcorpse" Timoshenko  
Alexander "Alan Parker"  
Nikolay Volodin  
Alexey "Alex Wolf"  
Andrey Kovalenko  
Alexander Mishkovich

Lead programmer  
Flight dynamics  
Engine systems  
Power plant, engine systems  
Avionics, weapons  
Systems of aircraft, avionics,  
effects, AI-helper, damage  
model  
Aircraft performance  
coordination  
Sound developer, music  
composer

Nikolay T

Konstantin Kuznetsov "btd"

#### DESIGNERS

Sergey Golovachev  
Maxim Lysov

3D-model of aircraft  
3D-model of aircraft, damage  
model  
3D-model of cockpit  
Pilots

Evgeny Khigniak  
Andrey Reshetko

## SCIENCE SUPPORT

Sergey "Vladimirovich"

modeling methodology

## TESTER STAFF

Alexander "BillyCrusher" Bilievsky

Ivan "Frogfoot" Makarov

Valery "Rik" Khomenok

Danny "Stuka" Vanvelthoven

Dmitry "Laivynas" Koshelev

Edin "Kuky" Kulelija

Erich "ViperVJG73" Schwarz

Jeff "Grimes" Szorc

Matthias "Groove" Techmanski

Nikita "Nim" Opredelekov

Norm "SiThSpAwN" Loewen

Oleg "Dzen" Fedorenko

Raul "Furia" Ortiz de Urbina

Roberto "Vibora" Seoane Penas

Scott "BIGNEWY" Newnham

Stephen "Nate--IRL--" Barrett

Valera "dragony" Manasyan

Werner "derelor" Siedenburg

William "SkateZilla" Belmont

## IT AND CUSTOMER SUPPORT

### MISSION AND CAMPAIGNS

Dmitry "Laivynas" Koshelev

Oleg "Dzen" Fedorenko

## ARTISTS AND SOUND

WIP



## TRAINING

Gene "EvilBivol-1" Bivol

Training missions, technical documentation, support forum

## SPECIAL THANKS

Heele Dmitry Vasilyevich. Jet aerobatic master of sports, who flew Yak-18, Yak-11, MiG-15, MiG-17, MiG-19, MiG-21. Reiterated participant of fly-pasts, awarded with order for MiG-21 combat flight tests. For advice on flight dynamics and system operation.

For advice on flight dynamics and system operation.

Julia "Umka" and Vitaly "Zulu" Marchuk

For professionalism and enthusiasm translating this manual text from Russian into English

Werner "derelor" Siedenburg

For professionalism and thoroughness in editing this manual



# 17

## BIBLIOGRAPHY AND SOURCES

## 17. BIBLIOGRAPHY AND SOURCES

1. Теория авиационных двигателей, часть 1, и 2 Учебник для ВУЗов ВВС/ Под ред. Ю. Н. Нечаева – М: ВВИА им. проф. Н.Е. Жуковского, 2006 – 448с .
2. Конструкция и прочность авиадвигателей. Учебное пособие/ Под ред. А. И. Евдакимова – М: ВВИА им. проф. Н.Е. Жуковского, 2007 – 340 с.
3. Сиротин Н. Н. Конструкция и эксплуатация, повреждаемость и работоспособность газотурбинных двигателей. М: РИА "ИМ-информ", 2002.
4. Конструкция и проектирование авиационных газотурбинных двигателей. / Под ред. Д. В. Хромина. – М: Машиностроение, 1989.
5. Mark D. Jane's aero-engines. – Alexandria, Virginia 22314, US: Jane's information Group inc, 2009. – 448 с.
6. С.М. Егер "Проектирование самолетов"
7. К.П. Петров "Аэродинамика элементов летательных аппаратов"
8. "Аэродинамика, устойчивость и управляемость сверхзвуковых самолётов" под ред. Г.С. Бюшгенса
9. R. Chambers, S. Grafton "Aerodynamics of airplanes at high angles-of-attack"
10. МиГ-15бис Технические описания. Кн.1–4. Москва, 1953:
  - книга I – „Летные характеристики самолета“;
  - книга II – „Вооружение самолета“;
  - книга III – „Конструкция самолета“;
  - книга IV – „Специальное оборудование самолета“.
11. Альбом наглядных пособий по самолётам МиГ-15бис и МиГ-17. Часть I. Техника пилотирования. Воениздат, 1969